



FLEET GRAPHICS MANUAL

MAY 3, 2024

4366 Mt. Pleasant St. NW
North Canton, Ohio 44720
Phone: 330-491-0474
www.thekag.com

For reorders, contact:



Advantage Tank Lines
KAG Food Products, LLC
KAG West
KAG Specialty Products Group, LLC
KAG Merchant Gas Group, LLC
KAG Energy
KAG West Energy

620-663-5939

<https://kenan.graphicimpressions1.com/>

- TABLE OF CONTENTS

BRANDING GUIDELINES	3	FOOD GRADE TRAILER / TANKER - KIT K50202 - \$106.98	41
COMPANY ORGANIZATION	4	CRUDE TRAILER / TANKER APPLICATION DIAGRAM	42
DAY CAB WHITE LAYOUT (PETERBILT 579 DAY CAB APPLICATION DIAGRAM	5	CRUDE TRAILER / TANKER - KIT K50501 - \$49.46	43
SLEEPER CAB WHITE LAYOUT (PETERBILT 579) APPLICATION DIAGRAM	6	EXPOSED RINGS - TRAILER/TANKER APPLICATION DIAGRAM	44
ADVANTAGE TANK LINES KIT LIST	7	EXPOSED RINGS - TRAILER/TANKER KIT LIST - KIT 50511 - \$49.46	45
KAG ENERGY, LLC KIT LIST	8	ASPHALT TRAILER / TANKER APPLICATION DIAGRAM	46
RETURN TO TABLE OF CONTENTS	8	ASPHALT TRAILER / TANKER - KIT K50509 - \$49.46	47
KAG FOOD PRODUCTS, LLC KIT LIST	9	FUEL TANKER APPLICATION DIAGRAM	48
KAG WEST KIT LIST	10	FUEL TANKER - KIT K50507 - \$94.82	49
RETURN TO TABLE OF CONTENTS	10	TRUCK TANK & PULL TANK APPLICATION DIAGRAM	50
KAG WEST ENERGY	11	TRUCK TANK & PULL TANK KIT 50500 - \$166.61	51
KAG SPECIALTY PRODUCTS GROUP, LLC KIT LIST	12	MERCHANT GAS GROUP TANKER APPLICATION DIAGRAM	52
KAG MERCHANT GAS GROUP, LLC KIT LIST	13	MERCHANT GAS GROUP TANKER - KIT K55148 - \$67.12	53
DAY CAB LAYOUT (MACK ANTHEM) - SPECIALTY PRODUCTS GROUP APPL. DIAGRAM	14	MERCHANT GAS KITS	54
SLEEPER CAB LAYOUT (MACK ANTHEM) SPECIALTY PRODUCTS GROUP APPL. DIAGRAM	15	MERCHANT GAS KITS	55
DAY CAB WHITE LAYOUT (MACK ANTHEM) APPLICATION DIAGRAM	16	SPECIALTY PRODUCTS GROUP TANKER APPLICATION DIAGRAM	56
SLEEPER CAB WHITE LAYOUT (MACK ANTHEM) APPLICATION DIAGRAM	17	SPECIALTY PRODUCTS GROUP TANKER - KIT K50506 - \$94.82	57
ADVANTAGE TANK LINES (FOR MACK ONLY) KIT LIST	18	TANKER - SULFUR APPLICATION DIAGRAM	58
KAG ENERGY, LLC (FOR MACK ONLY) KIT LIST	19	TANKER - SULFUR KIT K50513 - \$75.86	59
KAG FOOD PRODUCTS, LLC (FOR MACK ONLY) KIT LIST	20	BURNER TANK WITH SMOKE STACK/CHIMNEY APPLICATION DIAGRAM	60
KAG SPECIALTY PRODUCTS GROUP, LLC (FOR MACK ONLY) KIT LIST	21	BURNER TANK WITH SMOKE STACK/CHIMNEY - KIT K50514 - \$49.46	61
KAG WEST (FOR MACK ONLY) KIT LIST	22	PRODUCT IDENTIFICATION TANKER APPLICATION DIAGRAM	62
RETURN TO TABLE OF CONTENTS	23	PRODUCT IDENTIFICATION TANKER - K50510 - \$95.64	63
KAG MERCHANT GAS GROUP (FOR MACK ONLY) KIT LIST	24	39 FT. FRAMELESS DUMP TRUCK APPLICATION DIAGRAM	64
AG TRUCKING, INC. APPLICATION DIAGRAM	25	39 FT. FRAMELESS DUMP TRUCK - KIT K50512 - \$85.55	65
AG TRUCKING, INC. KIT LIST	26	PNEUMATIC TANKER TRAILER APPLICATION DIAGRAM	66
FORT TRANSFER - DAY CAB WHITE LAYOUT PETERBILT 579 DAY CAB	27	PNEUMATIC TANKER TRAILER - KIT K50523 - \$122.25	67
FORT TRANSFER - SLEEPER CAB WHITE LAYOUT PETERBILT 579	28	TANK CHASSIS APPLICATION DIAGRAM	68
FORT TRANSFER KIT	29	TANK CHASSIS - KIT K5.524 - \$62.54	69
LEASE OR OWNER/OPERATOR DECALS	30	MERCHANT GAS GROUP TANKER 4.2 IN. WORDS & 2 IN. WORDS	70
LEASE OR OWNER/OPERATOR DECALS	31	MERCHANT GAS GROUP 2 IN. WORDS CONTINUED	
KAG TRACTOR REPLACEMENT DECAL DETAIL	32	FOOD GROUP TANKER WORD DECALS	71
KAG TEMPORARY DECALS	33	SEQUENCE UNIT NUMBERS	72
DRY VAN / REEFER APPLICATION DIAGRAM	34	INDIVIDUAL UNIT NUMBERS	73
DRY VAN / REEFER - KIT K50204 - \$87.73	35	TANK COLLARS DECALS	74
28 FT. DRY VAN APPLICATION DIAGRAM	36	TANK COLLARS DECALS	75
28 FT. DRY VAN - KIT K50205 - \$87.73	37	KAG TANKER DECAL REPLACEMENT DETAIL	76
DRY VAN / REEFER (FOOD GRADE ONLY) APPLICATION DIAGRAM	38	KAG TANKER DECAL REPLACEMENT DETAIL	77
DRY VAN / REEFER (FOOD GRADE ONLY) - KIT K50200 - \$98.31	39	KAG TANKER DECAL REPLACEMENT DETAIL	78
FOOD GRADE TRAILER / TANKER APPLICATION DIAGRAM	40	KAG WALL DECALS	78
		CUSTOMER SPECIFIC DECALS	79
		MISCELLANEOUS	80
		MISCELLANEOUS	81
		MISCELLANEOUS	82
		MISCELLANEOUS	83

UNIT NUMBERS

- Typed with the font *Arial Bold*
- Kerning (Spacing between numbers)
Needs manually adjusted - See example below.

NOT APPROVED

65712566

APPROVED

65712566

USDOT NUMBERS

- Must be between 2.1" & 2.2" tall
- Kerning (Spacing between numbers)
Needs manually adjusted - See example above in unit numbers
- Typed with the font *Arial Narrow*

COLOR BUILDS

- LIGHT BLUE

C:77 M:27 Y:0 K:0

- DARK BLUE

C:100 M:80 Y:15 K:2

- RED

C:16 M:100 Y:87 K:7

- WHITE (RAW MATERIAL)

C:0.8 M:0.1 Y:0 K:0

DARK BLUE

LIGHT BLUE



FONT

- ARIAL FONT FAMILY
- BEBAS NEW FONT - USED FOR 2.5" TALL BLACK REFLECTIVE WORDS

RAW MATERIALS

- 3M IJ180cV3 white (Used for all printed decals)
- 8519 Luster Laminate (Used for all printed decals)
- 3M Sapphire Blue Pigmented Vinyl (Only used for unit numbers)
- 3M 680-85 (Black reflective)
- 30Mil Styrene (Used for tank collars)

TRACTOR COLOR

- Solid White

Leased or Owner/Operator truck door decals must be of the same size, font and style displayed here and be in compliance with the current FMCSR's.

THE KENAN ADVANTAGE GROUP, INC.

KAG ENERGY

Advantage Tank Lines
KAG West
KAG West Energy

**KAG
MERCHANT GAS**

KAG Merchant Gas Group, LLC

**KAG
FOOD PRODUCTS**

KAG Food Products, LLC
AG Trucking, Inc.

**KAG
SPECIALTY PRODUCTS**

KAG Specialty Products Group, LLC
Fort Transfer

- DAY CAB WHITE LAYOUT (PETERBILT 579 DAY CAB) APPLICATION DIAGRAM

KAG

ENERGY, LLC

USDOT# 469756

PART #: VARIES BASED ON SUBSIDIARY
VARIOUS SUBSIDIARIES WITH USDOT
VARIOUS SIZES

INSTALL 18" FROM THE HOOD SEAM
& 3" DOWN FROM THE WINDOW SEAL

DRIVER SIDE

PASSENGER SIDE

1234567

PART #: K20601

4" TALL UNIT NUMBER - SAPPHIRE BLUE

INSTALL UNIT NUMBER 18"
FROM THE FRONT & 3" ABOVE THE FENDER

1234567

3"

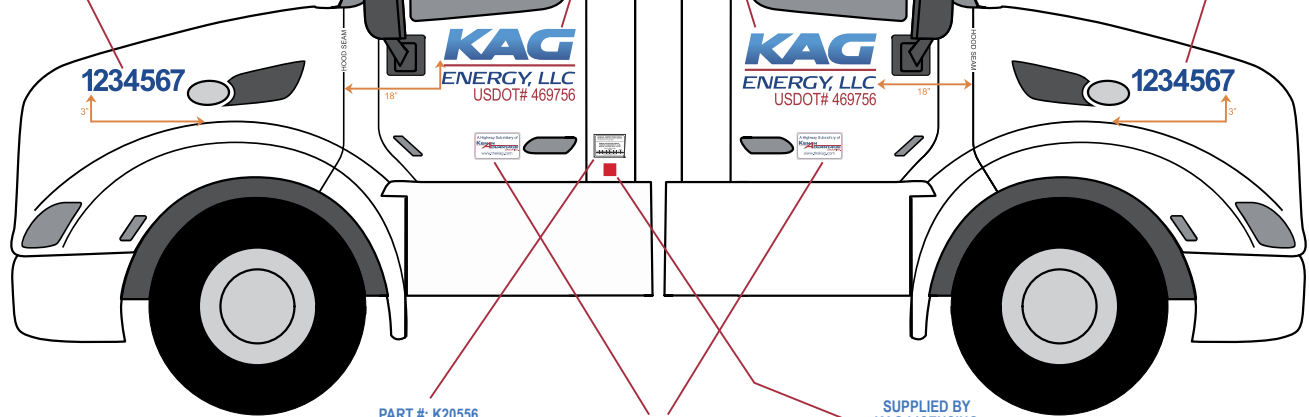

1234567

PART #: K20601

4" TALL UNIT NUMBER - SAPPHIRE BLUE

INSTALL UNIT NUMBER 18"
FROM THE FRONT & 3" ABOVE THE FENDER

1234567

3"

PART #: K20556
ANNUAL INSPECTION DECAL



INSTALL 1" ABOVE IFTA DECAL
CENTERED ON PILLAR

PART #: K20507
SUBSIDIARY OF DECAL



INSTALL 18" FROM THE HOOD SEAM &
5" UP FROM BOTTOM OF DOOR

SUPPLIED BY
KAG LICENSING
CONTACT FLEET SERVICES
330-409-1144
IFTA DECAL



INSTALL 1" UP
CENTERED ON PILLAR

1234567

PART #: K20600

2.5" TALL UNIT NUMBER - SAPPHIRE BLUE

INSTALL 2" FROM TOP SEAM &
2" FROM SIDE SEAM

REAR/BACK OF CAB

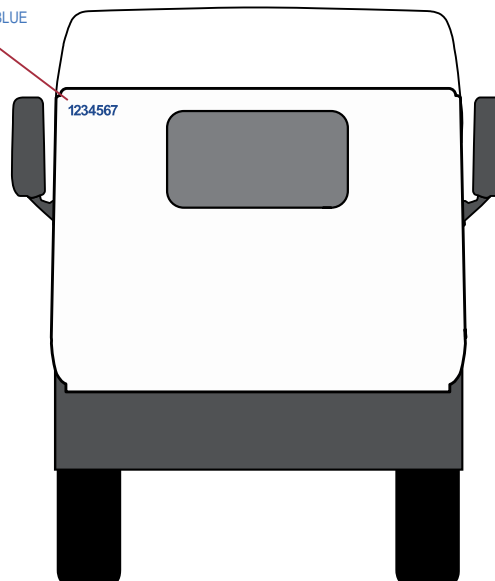

- SLEEPER CAB WHITE LAYOUT (PETERBILT 579) APPLICATION DIAGRAM

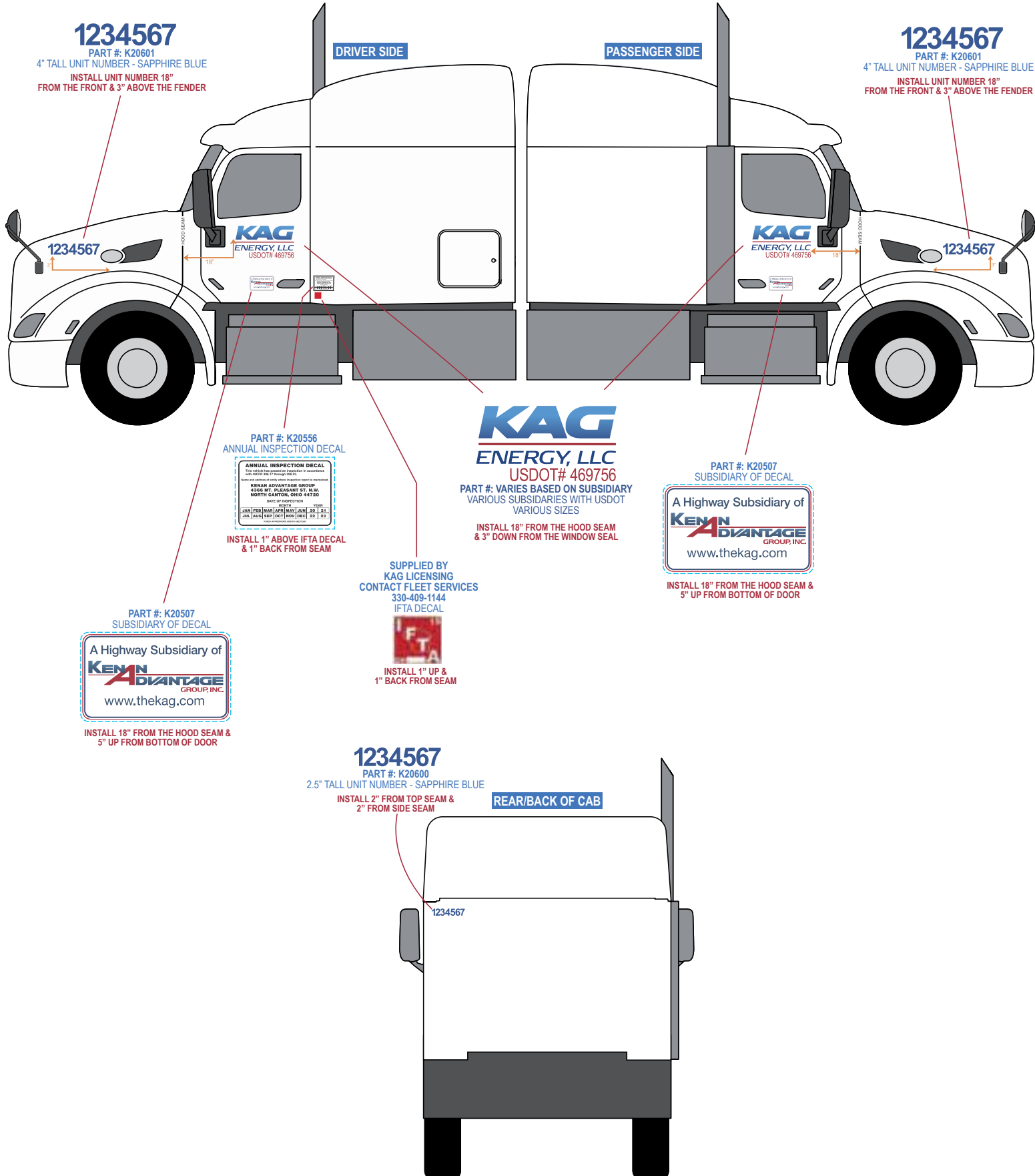

1234567
 PART #: K20601
 4" TALL UNIT NUMBER - SAPPHIRE BLUE
 INSTALL UNIT NUMBER 18"
 FROM THE FRONT & 3" ABOVE THE FENDER

1234567
 PART #: K20601
 4" TALL UNIT NUMBER - SAPPHIRE BLUE
 INSTALL UNIT NUMBER 18"
 FROM THE FRONT & 3" ABOVE THE FENDER

PART #: K20556
 ANNUAL INSPECTION DECAL

ANNUAL INSPECTION DECAL	
FOR OHIO USE ONLY - SEE OHIO MOTOR VEHICLE CODE, SECTION 4511.01	
ISSUED BY: KENN ADVANTAGE GROUP	
4205 W. PLEASANT ST., N.W.	
NORTH CANTON, OHIO 44720	
DATE OF EXPIRATION:	
JAN	FEB
MAR	APR
MAY	JUN
JUL	AUG
SEP	OCT
NOV	DEC
22	23
24	25

INSTALL 1" ABOVE IFTA DECAL
 & 1" BACK FROM SEAM

KAG
ENERGY, LLC
 USDOT# 469756

PART #: VARIES BASED ON SUBSIDIARY
 VARIOUS SUBSIDIARIES WITH USDOT
 VARIOUS SIZES

INSTALL 18" FROM THE HOOD SEAM
 & 3" DOWN FROM THE WINDOW SEAL

PART #: K20507
 SUBSIDIARY OF DECAL

A Highway Subsidiary of
KENN ADVANTAGE
 GROUP, INC.
 www.thekag.com

INSTALL 18" FROM THE HOOD SEAM &
 5" UP FROM BOTTOM OF DOOR

PART #: K20507
 SUBSIDIARY OF DECAL

A Highway Subsidiary of
KENN ADVANTAGE
 GROUP, INC.
 www.thekag.com

INSTALL 18" FROM THE HOOD SEAM &
 5" UP FROM BOTTOM OF DOOR

SUPPLIED BY
 KAG LICENSING
 CONTACT FLEET SERVICES
 330-409-1144
 IFTA DECAL



INSTALL 1" UP &
 1" BACK FROM SEAM

1234567
 PART #: K20600
 2.5" TALL UNIT NUMBER - SAPPHIRE BLUE
 INSTALL 2" FROM TOP SEAM &
 2" FROM SIDE SEAM

REAR/BACK OF CAB

- ADVANTAGE TANK LINES KIT LIST

Decals Needed for White Trucks

KIT - K10495





\$27.50

PART #	DESCRIPTION	QTY	PRICE	IMAGE
K20495	25.2" X 9.9" BLUE AND RED DOOR DECAL AND USDOT	2	\$9.72	
K20507	9.25" X 5.55" A HIGHWAY SUBSIDIARY DECAL	2	\$1.09	
K20601	4" TALL UNIT NUMBERS HORIZONTAL / SAPPHIRE BLUE	2	\$1.96	
K20600	2.5" TALL UNIT NUMBERS HORIZONTAL / SAPPHIRE BLUE	1	\$1.96	

Decals Needed for Colored Trucks - O/O

KIT - K10497

\$30.31

PART #	DESCRIPTION	QTY	PRICE	IMAGE
K20589	25.2" X 9.9" WHITE AND RED DOOR DECAL AND USDOT	2	\$10.77	
K20507	9.25" X 5.55" A HIGHWAY SUBSIDIARY DECAL	2	\$1.09	
K20510	4" TALL UNIT NUMBERS HORIZONTAL / WHITE	2	\$2.32	
K20511	2.5" TALL UNIT NUMBERS HORIZONTAL / WHITE	1	\$1.95	





**Decals can be ordered individually if needed.

- KAG ENERGY, LLC KIT LIST

Decals Needed for White Trucks

KIT - K35155





\$23.82

PART #	DESCRIPTION	QTY	PRICE	IMAGE
K30490	22.35" X 12.9" BLUE AND RED DOOR DECAL AND USDOT	2	\$7.88	
K20507	9.25" X 5.55" A HIGHWAY SUBSIDIARY DECAL	2	\$1.09	
K20601	4" TALL UNIT NUMBERS HORIZONTAL / SAPPHIRE BLUE	2	\$1.96	
K20600	2.5" TALL UNIT NUMBERS HORIZONTAL / SAPPHIRE BLUE	1	\$1.96	

Decals Needed for Colored Trucks - O/O

KIT - K35156

\$24.95

PART #	DESCRIPTION	QTY	PRICE	IMAGE
K30491	22.35" X 12.9" WHITE AND RED DOOR DECAL AND USDOT	2	\$8.09	
K20507	9.25" X 5.55" A HIGHWAY SUBSIDIARY DECAL	2	\$1.09	
K20510	4" TALL UNIT NUMBERS HORIZONTAL / WHITE	2	\$2.32	
K20511	2.5" TALL UNIT NUMBERS HORIZONTAL / WHITE	1	\$1.95	



****Decals can be ordered individually if needed.**

- KAG FOOD PRODUCTS, LLC KIT LIST

Decals Needed for White Trucks

KIT - K15152



\$25.56

PART #	DESCRIPTION	QTY	PRICE	IMAGE
K25152	25" X 15.8" BLUE AND RED DOOR DECAL AND USDOT	2	\$9.84	
K20601	4" TALL UNIT NUMBERS HORIZONTAL / SAPPHIRE BLUE	2	\$1.96	
K20600	2.5" TALL UNIT NUMBERS HORIZONTAL / SAPPHIRE BLUE	1	\$1.96	

Decals Needed for Colored Trucks - O/O

KIT - K15154

\$28.13

PART #	DESCRIPTION	QTY	PRICE	IMAGE
K25153	25" X 15.8" WHITE AND RED DOOR DECAL AND USDOT	2	\$10.77	
K20510	4" TALL UNIT NUMBERS HORIZONTAL / WHITE	2	\$2.32	
K20511	2.5" TALL UNIT NUMBERS HORIZONTAL / WHITE	1	\$1.95	



****Decals can be ordered individually if needed.**

- KAG WEST KIT LIST

Decals Needed for White Trucks

KIT - K10500



\$25.32

PART #	DESCRIPTION	QTY	PRICE	IMAGE
K20500	25" X 12.8" BLUE AND RED DOOR DECAL AND USDOT	2	\$9.72	
K20601	4" TALL UNIT NUMBERS HORIZONTAL / SAPPHIRE BLUE	2	\$1.96	
K20600	2.5" TALL UNIT NUMBERS HORIZONTAL / SAPPHIRE BLUE	1	\$1.96	

Decals Needed for Colored Trucks - O/O

KIT - K10503

\$28.13

PART #	DESCRIPTION	QTY	PRICE	IMAGE
K20594	25" X 12.8" WHITE AND RED DOOR DECAL AND USDOT	2	\$10.77	
K20510	4" TALL UNIT NUMBERS HORIZONTAL / WHITE	2	\$2.32	
K20511	2.5" TALL UNIT NUMBERS HORIZONTAL / WHITE	1	\$1.95	



****Decals can be ordered individually if needed.**

- KAG WEST ENERGY

Decals Needed for White Trucks

KIT - K35161



\$27.42

PART #	DESCRIPTION	QTY	PRICE	IMAGE
K30430	12" X 22.84" BLUE AND RED DOOR DECAL AND USDOT	2	\$10.77	
K20601	4" TALL UNIT NUMBERS HORIZONTAL / SAPPHIRE BLUE	2	\$1.96	
K20600	2.5" TALL UNIT NUMBERS HORIZONTAL / SAPPHIRE BLUE	1	\$1.96	

Decals Needed for Colored Trucks - O/O

KIT - K35162

\$28.13

PART #	DESCRIPTION	QTY	PRICE	IMAGE
K30431	12" X 22.84" RED AND WHITE DOOR DECAL AND USDOT	2	\$10.77	
K20510	4" TALL UNIT NUMBERS HORIZONTAL / WHITE	2	\$2.32	
K20511	2.5" TALL UNIT NUMBERS HORIZONTAL / WHITE	1	\$1.95	



****Decals can be ordered individually if needed.**

- KAG SPECIALTY PRODUCTS GROUP, LLC KIT LIST

Decals Needed for White Trucks

KIT - K15150



\$25.32

PART #	DESCRIPTION	QTY	PRICE	IMAGE
K25150	25" X 15.8" BLUE AND RED DOOR DECAL AND USDOT	2	\$9.72	
K20601	4" TALL UNIT NUMBERS HORIZONTAL / SAPPHIRE BLUE	2	\$1.96	
K20600	2.5" TALL UNIT NUMBERS HORIZONTAL / SAPPHIRE BLUE	1	\$1.96	

Decals Needed for Colored Trucks - O/O

KIT - K15151

\$26.27

PART #	DESCRIPTION	QTY	PRICE	IMAGE
K25151	25" X 15.8" WHITE AND RED DOOR DECAL AND USDOT	2	\$9.84	
K20510	4" TALL UNIT NUMBERS HORIZONTAL / WHITE	2	\$2.32	
K20511	2.5" TALL UNIT NUMBERS HORIZONTAL / WHITE	1	\$1.95	



****Decals can be ordered individually if needed.**

- KAG MERCHANT GAS GROUP, LLC KIT LIST

Decals Needed for White Trucks

KIT - K15148



\$25.32

PART #	DESCRIPTION	QTY	PRICE	IMAGE
K25148	25" X 15.8" BLUE AND RED DOOR DECAL AND USDOT	2	\$9.72	
K20601	4" TALL UNIT NUMBERS HORIZONTAL / SAPPHIRE BLUE	2	\$1.96	
K20600	2.5" TALL UNIT NUMBERS HORIZONTAL / SAPPHIRE BLUE	1	\$1.96	

Decals Needed for Colored Trucks - O/O

KIT - K15149

\$28.13

PART #	DESCRIPTION	QTY	PRICE	IMAGE
K25149	25" X 15.8" WHITE AND RED DOOR DECAL AND USDOT	2	\$10.77	
K20510	4" TALL UNIT NUMBERS HORIZONTAL / WHITE	2	\$2.32	
K20511	2.5" TALL UNIT NUMBERS HORIZONTAL / WHITE	1	\$1.95	

****Decals can be ordered individually if needed.**

- SLEEPER CAB LAYOUT (MACK ANTHEM) SPECIALTY PRODUCTS GROUP APPL. DIAGRAM

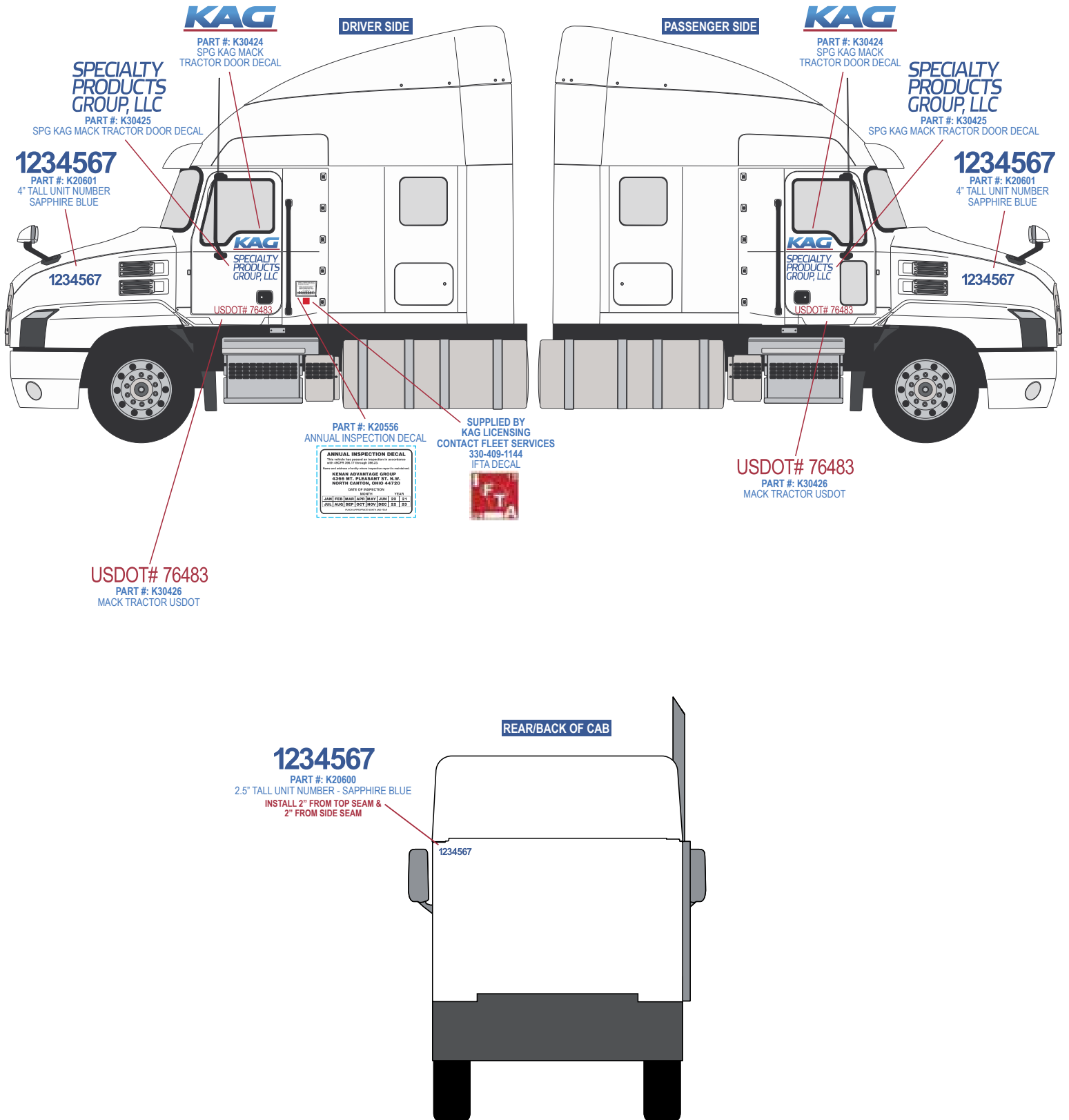

- DAY CAB WHITE LAYOUT (MACK ANTHEM) APPLICATION DIAGRAM

KAG
ENERGY, LLC
 USDOT# 469756

PART #: VARIES BASED ON SUBSIDIARY
 VARIOUS SUBSIDIARIES WITH USDOT
 VARIOUS SIZES

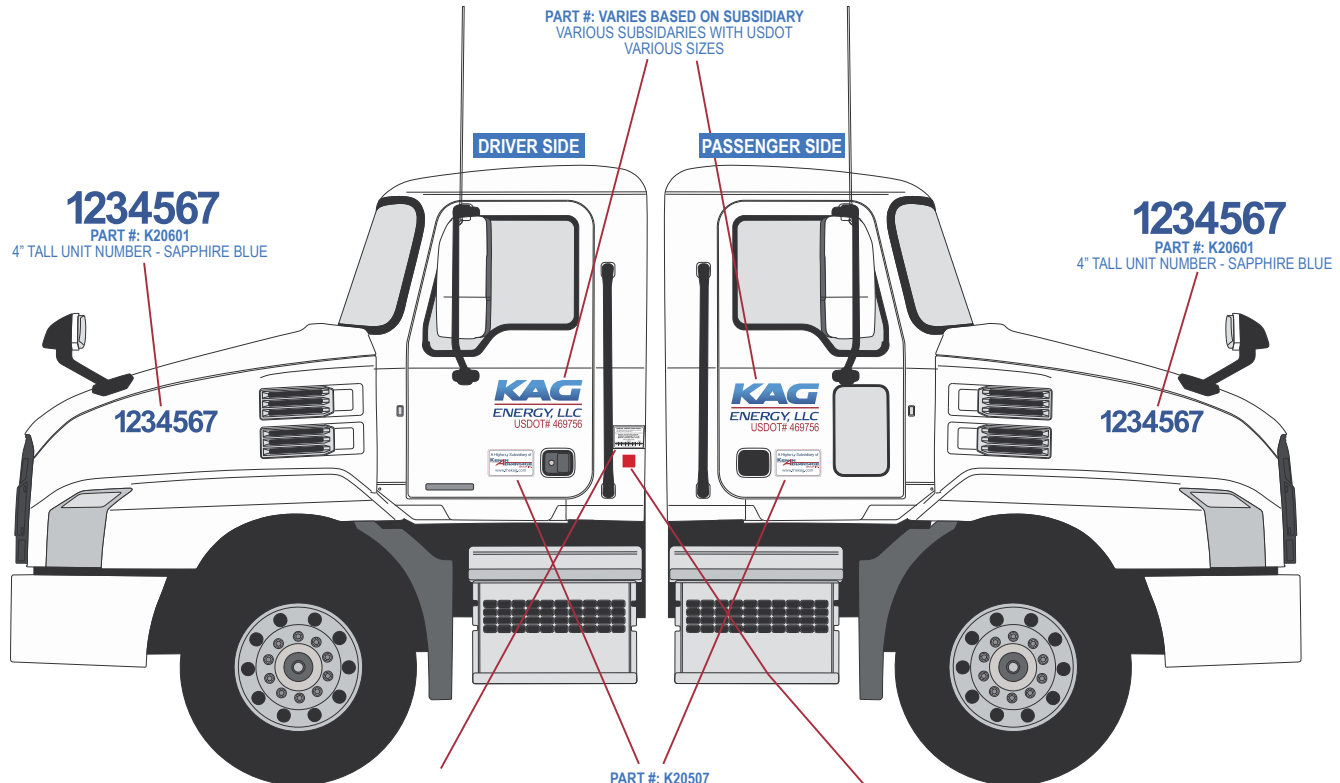

1234567
 PART #: K20601
 4" TALL UNIT NUMBER - SAPPHIRE BLUE

1234567
 PART #: K20601
 4" TALL UNIT NUMBER - SAPPHIRE BLUE

DRIVER SIDE

PASSENGER SIDE

1234567

1234567

PART #: K20556
 ANNUAL INSPECTION DECAL



PART #: K20507
 SUBSIDIARY OF DECAL



SUPPLIED BY
 KAG LICENSING
 CONTACT FLEET SERVICES
 330-409-1144
 IFTA DECAL



1234567
 PART #: K20600
 2.5" TALL UNIT NUMBER - SAPPHIRE BLUE
 INSTALL 2" FROM TOP SEAM &
 2" FROM SIDE SEAM

REAR/BACK OF CAB

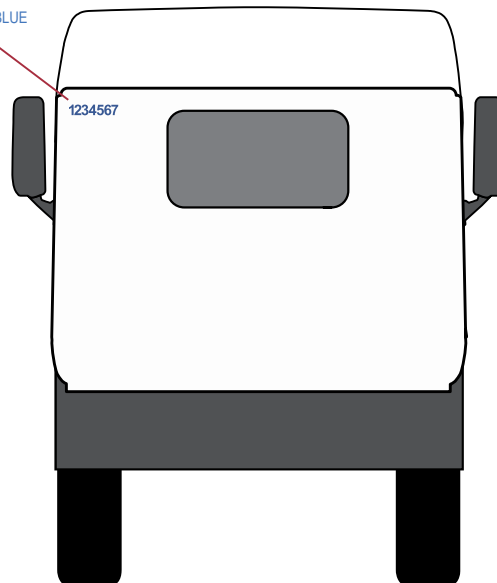

1234567

- SLEEPER CAB WHITE LAYOUT (MACK ANTHEM) APPLICATION DIAGRAM

KAG

ENERGY, LLC

USDOT# 469756

PART #: VARIES BASED ON SUBSIDIARY
VARIOUS SUBSIDIARIES WITH USDOT
VARIOUS SIZES

DRIVER SIDE

PASSENGER SIDE

KAG

ENERGY, LLC

USDOT# 469756

PART #: VARIES BASED ON SUBSIDIARY
VARIOUS SUBSIDIARIES WITH USDOT
VARIOUS SIZES

1234567

PART #: K20601
4" TALL UNIT NUMBER
SAPPHIRE BLUE

1234567

PART #: K20601
4" TALL UNIT NUMBER
SAPPHIRE BLUE

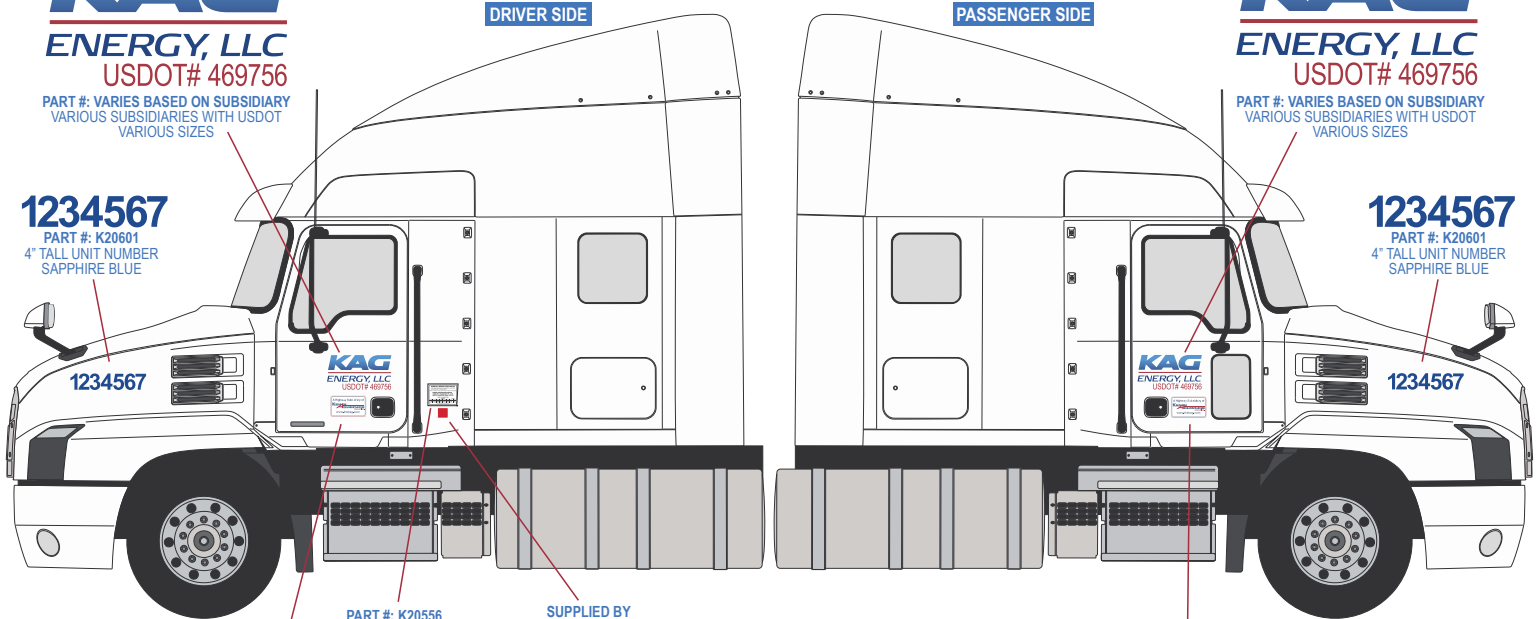

PART #: K20556
ANNUAL INSPECTION DECAL



SUPPLIED BY
KAG LICENSING
CONTACT FLEET SERVICES
330-409-1144
IFTA DECAL



PART #: K20507
SUBSIDIARY OF DECAL



PART #: K20507
SUBSIDIARY OF DECAL



REAR/BACK OF CAB

1234567



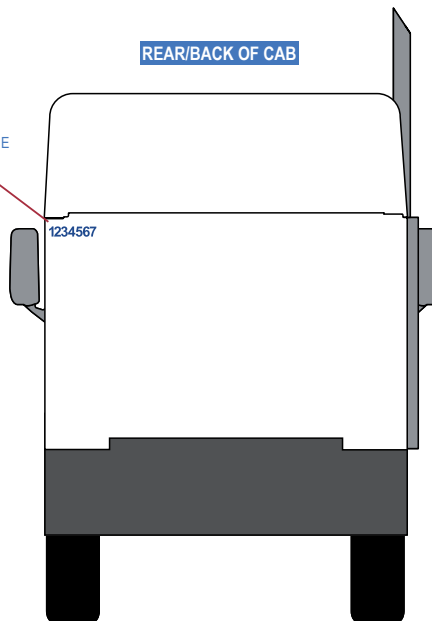

PART #: K20600
2.5" TALL UNIT NUMBER - SAPPHIRE BLUE
INSTALL 2" FROM TOP SEAM &
2" FROM SIDE SEAM



- ADVANTAGE TANK LINES (FOR MACK ONLY) KIT LIST





Decals Needed for White Trucks

KIT - K30495 \$27.50

PART #	DESCRIPTION	QTY	PRICE	IMAGE
K20495M	19.1" X 8.4" MACK ADVANTAGE TANK LINES MACK TRACTOR DOOR DECAL RED/BLUE	2	\$9.72	
K20507	9.25" X 5.55" A HIGHWAY SUBSIDIARY DECAL	2	\$1.09	
K20601	4" TALL UNIT NUMBERS HORIZONTAL / SAPPHIRE BLUE	2	\$1.96	
K20600	2.5" TALL UNIT NUMBERS HORIZONTAL / SAPPHIRE BLUE	1	\$1.96	

Decals Needed for Colored Trucks - O/O

KIT - K30497 \$30.31





PART #	DESCRIPTION	QTY	PRICE	IMAGE
K20589	19.1" X 8.4" MACK ADVANTAGE TANK LINES MACK TRACTOR DOOR DECAL WHITE/RED	2	\$10.77	
K20507	9.25" X 5.55" A HIGHWAY SUBSIDIARY DECAL	2	\$1.09	
K20510	4" TALL UNIT NUMBERS HORIZONTAL / WHITE	2	\$2.32	
K20511	2.5" TALL UNIT NUMBERS HORIZONTAL / WHITE	1	\$1.95	

****Decals can be ordered individually if needed.**

- KAG ENERGY, LLC (FOR MACK ONLY) KIT LIST





Decals Needed for White Trucks

KIT - K35157 \$22.32

PART #	DESCRIPTION	QTY	PRICE	IMAGE
K30492	20" X 11.16" BLUE AND RED DOOR DECAL AND USDOT	2	\$7.13	
K20507	9.25" X 5.55" A HIGHWAY SUBSIDIARY DECAL	2	\$1.09	
K20601	4" TALL UNIT NUMBERS HORIZONTAL / SAPPHIRE BLUE	2	\$1.96	
K20600	2.5" TALL UNIT NUMBERS HORIZONTAL / SAPPHIRE BLUE	1	\$1.96	

Decals Needed for Colored Trucks - O/O

KIT - K35158 \$23.07



PART #	DESCRIPTION	QTY	PRICE	IMAGE
K30493	20" X 11.16" WHITE AND RED DOOR DECAL AND USDOT	2	\$7.15	
K20507	9.25" X 5.55" A HIGHWAY SUBSIDIARY DECAL	2	\$1.09	
K20510	4" TALL UNIT NUMBERS HORIZONTAL / WHITE	2	\$2.32	
K20511	2.5" TALL UNIT NUMBERS HORIZONTAL / WHITE	1	\$1.95	

**Decals can be ordered individually if needed.

- KAG FOOD PRODUCTS, LLC (FOR MACK ONLY) KIT LIST



Decals Needed for White Trucks

KIT - K35152 \$25.56

PART #	DESCRIPTION	QTY	PRICE	IMAGE
K25152M	20 X 10.40" MACK TRUCK KAG FOOD PRODUCTS MACK TRACTOR DOOR DECAL RED/BLUE	2	\$9.84	
K20601	4" TALL UNIT NUMBERS HORIZONTAL / SAPPHIRE BLUE	2	\$1.96	
K20600	2.5" TALL UNIT NUMBERS HORIZONTAL / SAPPHIRE BLUE	1	\$1.96	

Decals Needed for Colored Trucks - O/O

KIT - K35154 \$22.32





PART #	DESCRIPTION	QTY	PRICE	IMAGE
K25153M	20" X 10.4" MACK TRUCK KAG FOOD PRODUCTS MACK TRACTOR DOOR DECAL WHITE/RED	2	\$10.77	
K20510	4" TALL UNIT NUMBERS HORIZONTAL / WHITE	2	\$2.32	
K20511	2.5" TALL UNIT NUMBERS HORIZONTAL / WHITE	1	\$1.95	

****Decals can be ordered individually if needed.**

- KAG SPECIALTY PRODUCTS GROUP, LLC (FOR MACK ONLY) KIT LIST





Decals Needed for White Trucks

KIT - K35150 \$62.30

PART #	DESCRIPTION	QTY	PRICE	IMAGE
K30424	12.6" X 3.4" SPG KAG MACK TRACTOR DOOR DECAL BLUE/RED	2	\$9.84	
K30425	12.6" X 7.1" MACK TRACTOR DOOR - BLUE	2	\$9.84	
K30426	15.6" X 2.1" SPG USDOT # 76483 MACK TRACTOR DOOR DECAL - RED	2	\$8.53	
K20601	4" TALL UNIT NUMBERS HORIZONTAL / SAPPHIRE BLUE	2	\$1.96	
K20600	2.5" TALL UNIT NUMBERS HORIZONTAL / SAPPHIRE BLUE	1	\$1.96	

Decals Needed for Colored Trucks - O/O

KIT - K35151 \$50.49

PART #	DESCRIPTION	QTY	PRICE	IMAGE
K25154	12.6" X 3.4" SPG KAG MACK TRACTOR DOOR DECAL WHITE/RED	2	\$10.77	
K25155	12.6" X 7.1" MACK TRACTOR DOOR - WHITE	2	\$9.84	
K25156	15.6" X 2.1" SPG USDOT # 76483 MACK TRACTOR DOOR DECAL - WHITE	2	\$1.34	
K20510	4" TALL UNIT NUMBERS HORIZONTAL / WHITE	2	\$2.32	
K20511	2.5" TALL UNIT NUMBERS HORIZONTAL / WHITE	1	\$1.95	



****Decals can be ordered individually if needed.**

- KAG WEST (FOR MACK ONLY) KIT LIST

Decals Needed for White Trucks

KIT - K30500



\$25.32

PART #	DESCRIPTION	QTY	PRICE	IMAGE
K20500M	16.9" X 9.2" KAG WEST MACK TRACTOR DOOR DECAL RED/BLUE	2	\$9.72	
K20601	4" TALL UNIT NUMBERS HORIZONTAL / SAPPHIRE BLUE	2	\$1.96	
K20600	2.5" TALL UNIT NUMBERS HORIZONTAL / SAPPHIRE BLUE	1	\$1.96	

Decals Needed for Colored Trucks - O/O

KIT - K30503

\$28.13

PART #	DESCRIPTION	QTY	PRICE	IMAGE
K20594MW	16.9" X 9.2" KAG WEST MACK TRACTOR DOOR DECAL RED/WHITE	2	\$10.77	
K20510	4" TALL UNIT NUMBERS HORIZONTAL / WHITE	2	\$2.32	
K20511	2.5" TALL UNIT NUMBERS HORIZONTAL / WHITE	1	\$1.95	



****Decals can be ordered individually if needed.**

- KAG WEST ENERGY (MACK ONLY) KIT LIST

Decals Needed for White Trucks

KIT - K35163



\$27.42

PART #	DESCRIPTION	QTY	PRICE	IMAGE
K30432	11.16" X 20.3" DOOR DECAL MACK RED AND BLUE	2	\$10.77	
K20601	4" TALL UNIT NUMBERS HORIZONTAL / SAPPHIRE BLUE	2	\$1.96	
K20600	2.5" TALL UNIT NUMBERS HORIZONTAL / SAPPHIRE BLUE	1	\$1.96	

Decals Needed for Colored Trucks - O/O

KIT - K35164

\$28.13

PART #	DESCRIPTION	QTY	PRICE	IMAGE
K30433	11.16" X 20.3" DOOR DECAL MACK RED AND WHITE	2	\$10.77	
K20510	4" TALL UNIT NUMBERS HORIZONTAL / WHITE	2	\$2.32	
K20511	2.5" TALL UNIT NUMBERS HORIZONTAL / WHITE	1	\$1.95	



****Decals can be ordered individually if needed.**

- KAG MERCHANT GAS GROUP (FOR MACK ONLY) KIT LIST

Decals Needed for White Trucks

KIT - K35148



\$25.32

PART #	DESCRIPTION	QTY	PRICE	IMAGE
K25148M	20" X 13.5" KAG MERCHANT GAS GROUP MACK TRACTOR DOOR DECAL RED/BLUE	2	\$9.72	
K20601	4" TALL UNIT NUMBERS HORIZONTAL / SAPPHIRE BLUE	2	\$1.96	
K20600	2.5" TALL UNIT NUMBERS HORIZONTAL / SAPPHIRE BLUE	1	\$1.96	

Decals Needed for Colored Trucks - O/O

KIT - K35149

\$28.13

PART #	DESCRIPTION	QTY	PRICE	IMAGE
K25149MW	20" X 13.5" KAG MERCHANT GAS GROUP MACK TRACTOR DOOR DECAL RED/WHITE	2	\$10.77	
K20510	4" TALL UNIT NUMBERS HORIZONTAL / WHITE	2	\$2.32	
K20511	2.5" TALL UNIT NUMBERS HORIZONTAL / WHITE	1	\$1.95	

****Decals can be ordered individually if needed.**

- AG TRUCKING, INC. APPLICATION DIAGRAM

(PETERBILT 579 DAY CAB & SLEEPER CAB)



TRUCKING, INC.

PART #: K30472
AG DOOR LOGO 8.25" X 31.5"

INSTALL 17.75" UP FROM
BOTTOM OF DOOR.
CENTER LEFT AND RIGHT.

1234567

PART #: K20488
4" TALL UNIT NUMBER - BLACK

INSTALL UNIT NUMBER 8"
FROM THE FRONT & 4.5" ABOVE THE FENDER

DRIVER SIDE

PASSENGER SIDE



TRUCKING, INC.

PART #: K30472
AG DOOR LOGO 8.25" X 31.5"

INSTALL 17.75" UP FROM
BOTTOM OF DOOR.
CENTER LEFT AND RIGHT.

1234567

PART #: K20488
4" TALL UNIT NUMBER - BLACK

INSTALL UNIT NUMBER 8"
FROM THE FRONT & 4.5" ABOVE THE FENDER

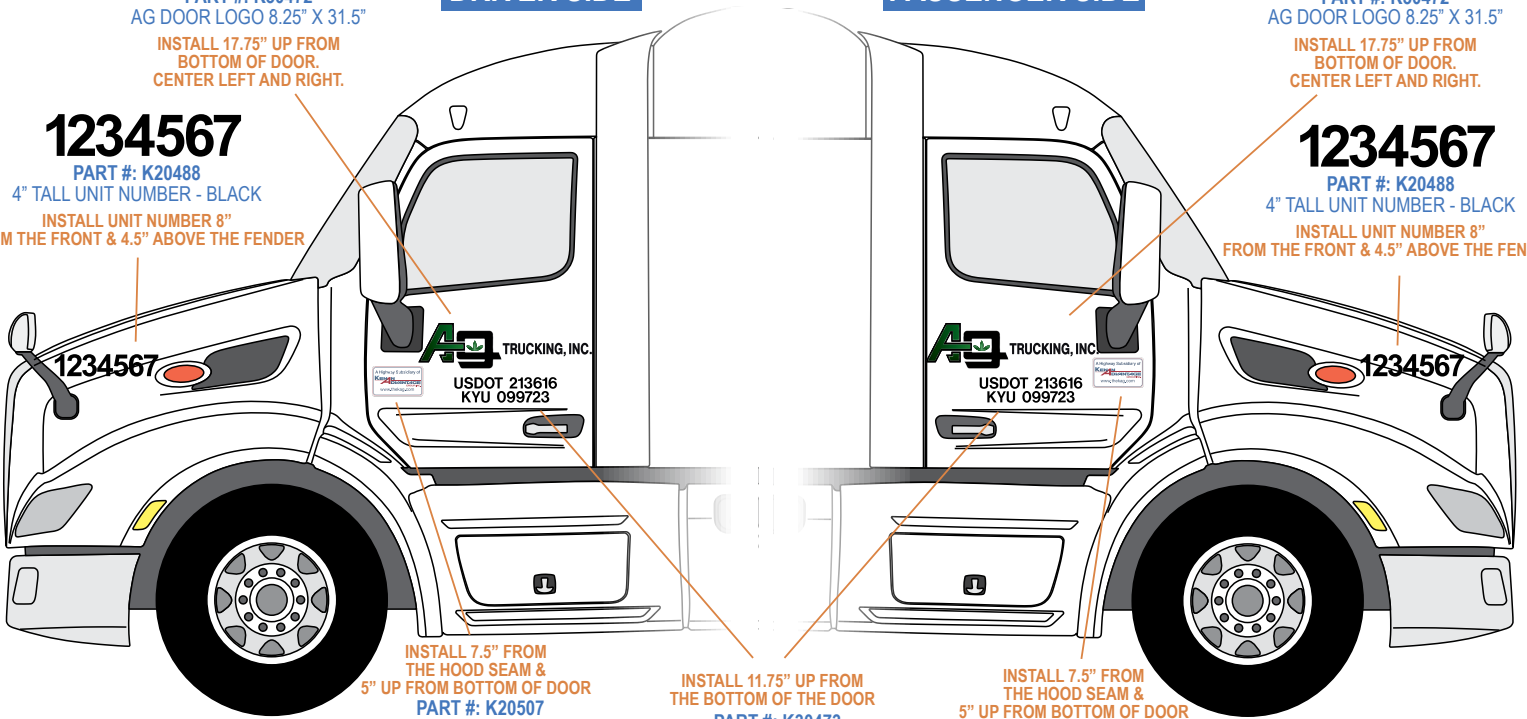

INSTALL 7.5" FROM
THE HOOD SEAM &
5" UP FROM BOTTOM OF DOOR

PART #: K20507
SUBSIDIARY OF DECAL



INSTALL 11.75" UP FROM
THE BOTTOM OF THE DOOR

PART #: K30473

USDOT 213616
KYU 099723

INSTALL 7.5" FROM
THE HOOD SEAM &
5" UP FROM BOTTOM OF DOOR

PART #: K20507
SUBSIDIARY OF DECAL



1234567

PART #: K20994
2.5" TALL UNIT NUMBER - BLACK

INSTALL 2" FROM TOP SEAM &
2" FROM SIDE SEAM

REAR/BACK OF CAB

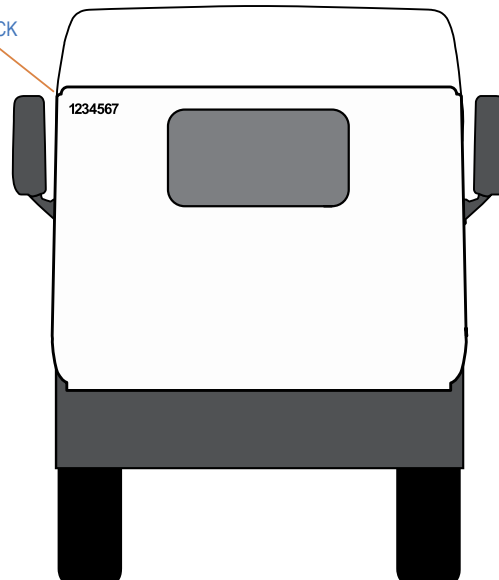

- AG TRUCKING, INC. KIT LIST

Decals for Sleeper and Day Cabs

KIT - K35159

\$43.84

PART #	DESCRIPTION	QTY	PRICE	IMAGE
K30472	8.25" X 31.5" DOOR DECAL	2	\$11.68	
K20507	9.25" X 5.55" A HIGHWAY SUBSIDIARY DECAL	2	\$1.09	
K20488	4" TALL UNIT NUMBERS HORIZONTAL / BLACK	2	\$2.32	1234567
K20994	2.5" TALL UNIT NUMBERS HORIZONTAL / BLACK	1	\$1.90	1234567
K30473	2" TALL LETTERS USDOT (4.66" X 18.62")	2	\$5.88	USDOT 213616 KYU 099723

****Decals can be ordered individually if needed.**

- FORT TRANSFER - DAY CAB WHITE LAYOUT PETERBILT 579 DAY CAB



MORTON, ILLINOIS

USDOT 134578 ILCC 10401

PART #: VARIES BASED ON SUBSIDIARY
VARIOUS SUBSIDIARIES WITH USDOT
VARIOUS SIZES

INSTALL 18" FROM THE HOOD SEAM
& 3" DOWN FROM THE WINDOW SEAL

DRIVER SIDE

PASSENGER SIDE

1234567

PART #: K20488

4" TALL UNIT NUMBER - BLACK

INSTALL UNIT NUMBER 18"
FROM THE FRONT & 3" ABOVE THE FENDER

1234567

PART #: K20488

4" TALL UNIT NUMBER - BLACK

INSTALL UNIT NUMBER 18"
FROM THE FRONT & 3" ABOVE THE FENDER

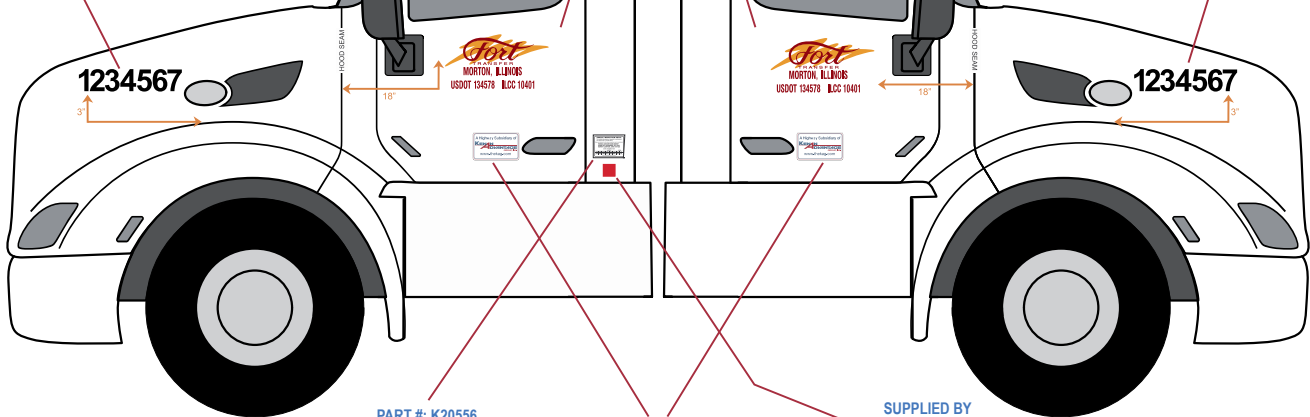

PART #: K20556
ANNUAL INSPECTION DECAL



INSTALL 1" ABOVE IFTA DECAL
CENTERED ON PILLAR

PART #: K20507
SUBSIDIARY OF DECAL



INSTALL 18" FROM THE HOOD SEAM &
5" UP FROM BOTTOM OF DOOR

SUPPLIED BY
KAG LICENSING
CONTACT FLEET SERVICES
330-409-1144
IFTA DECAL



INSTALL 1" UP
CENTERED ON PILLAR

1234567

PART #: K20994

2.5" TALL UNIT NUMBER - BLACK

INSTALL 2" FROM TOP SEAM &
2" FROM SIDE SEAM

REAR/BACK OF CAB

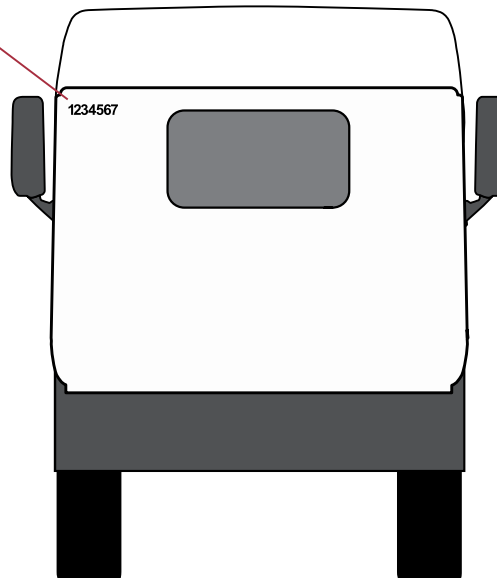

- FORT TRANSFER - SLEEPER CAB WHITE LAYOUT PETERBILT 579

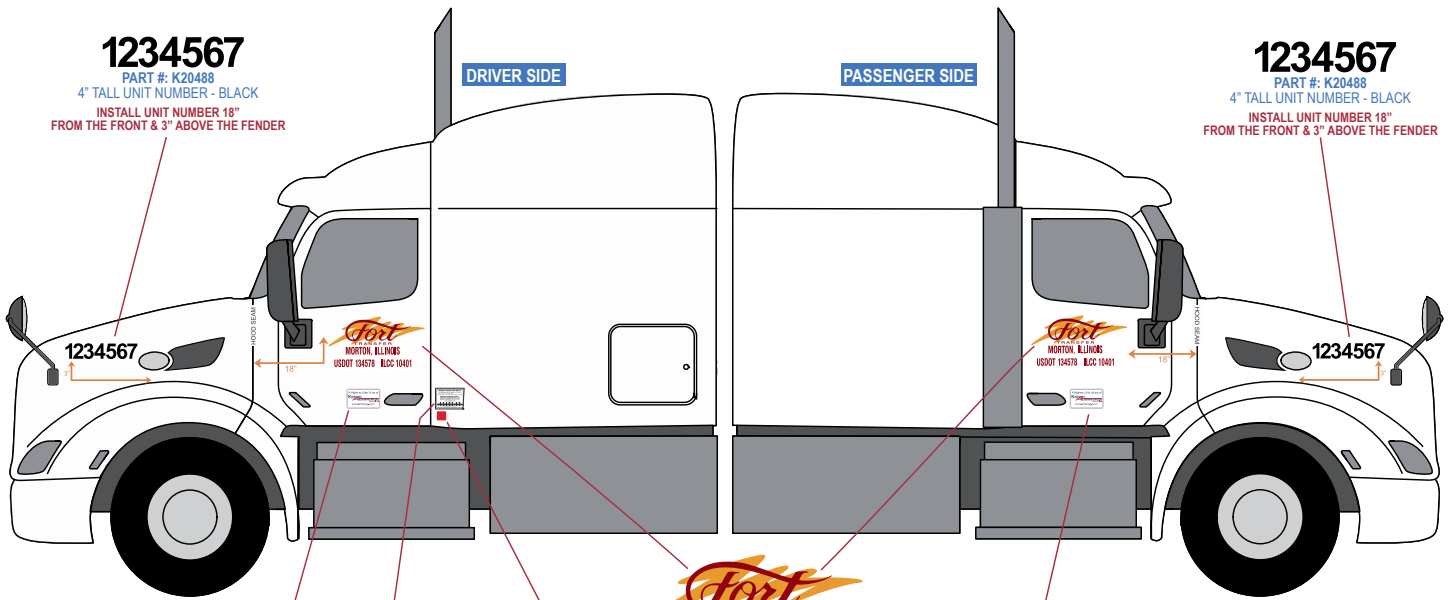

1234567

PART #: K20488
4" TALL UNIT NUMBER - BLACK
INSTALL UNIT NUMBER 18"
FROM THE FRONT & 3" ABOVE THE FENDER

1234567

PART #: K20488
4" TALL UNIT NUMBER - BLACK
INSTALL UNIT NUMBER 18"
FROM THE FRONT & 3" ABOVE THE FENDER

PART #: K20556
ANNUAL INSPECTION DECAL



INSTALL 1" ABOVE IFTA DECAL
& 1" BACK FROM SEAM



USDOT 134578 ILCC 10401

PART #: VARIES BASED ON SUBSIDIARY
VARIOUS SUBSIDIARIES WITH USDOT
VARIOUS SIZES

INSTALL 18" FROM THE HOOD SEAM
& 3" DOWN FROM THE WINDOW SEAL

PART #: K20507
SUBSIDIARY OF DECAL



INSTALL 18" FROM THE HOOD SEAM &
5" UP FROM BOTTOM OF DOOR

PART #: K20507
SUBSIDIARY OF DECAL



INSTALL 18" FROM THE HOOD SEAM &
5" UP FROM BOTTOM OF DOOR

SUPPLIED BY
KAG LICENSING
CONTACT FLEET SERVICES
330-409-1144
IFTA DECAL



INSTALL 1" UP &
1" BACK FROM SEAM

1234567

PART #: K20994
2.5" TALL UNIT NUMBER - BLACK
INSTALL 2" FROM TOP SEAM &
2" FROM SIDE SEAM

REAR/BACK OF CAB

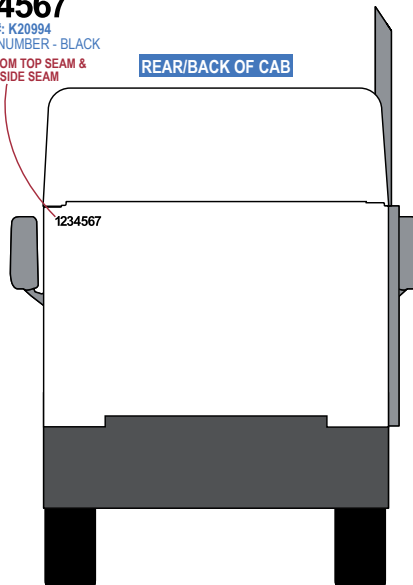



- FORT TRANSFER KIT

Decals for Sleeper and Day Cabs





KIT - K35160

\$50.96

PART #	DESCRIPTION	QTY	PRICE	IMAGE
K30509	10.5" X 25.85" FORT TRANSFER DOOR DECAL, RED & YELLOW RED LETTERS -R:140, G:0, B:0 YELLOW SPLASH- CREATED WITH SCOTCHLITE 680CR REFLECTIVE VINYL IN YELLOW	2	\$17.06	
K20507	9.25" X 5.55" A HIGHWAY SUBSIDIARY DECAL	2	\$1.09	
K20488	4" TALL UNIT NUMBER SEQUENCE HORIZONTAL/ BLACK VINYL	2	\$2.32	1234567890
K20994	2.5" TALL UNIT NUMBER SEQUENCE HORIZONTAL/ BLACK VINYL	1	\$1.90	1234567890
K30510	2.1" X 20.65" FORT TRANSFER DOT NUMBER	2	\$4.06	USDOT 134578 ILCC 10401

****Decals can be ordered individually if needed.**







- LEASE OR OWNER/OPERATOR DECALS

PART #	DESCRIPTION	QUANTITY	IMAGE
K30343	21" X 8" OPERATED BY: ADVANTAGE TANK LINES	2	
K30345	21" X 8" OPERATED BY: KAG WEST	2	
K30348	21" X 8" OPERATED BY: KAG MERCHANT GAS GROUP, LLC	2	
K30349	21" X 8" OPERATED BY: KAG ENERGY, LLC	2	

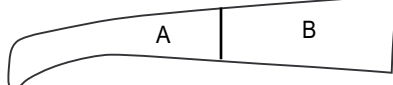
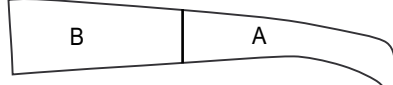



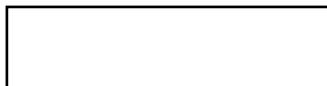

- LEASE OR OWNER/OPERATOR DECALS

PART #	DESCRIPTION	QUANTITY	IMAGE
K134406R	17" X 3" USDOT # 134406 - RED	2	USDOT# 134406
K134406W	17" X 3" USDOT # 134406 - WHITE	2	USDOT# 134406
K210140R	17" X 3" USDOT # 210140 - RED	2	USDOT# 210140
K210140W	17" X 3" USDOT # 210140 - WHITE	2	USDOT# 210140
K20490	17" X 3" USDOT # 469756 - RED	2	USDOT# 469756
K20588	17" X 3" USDOT # 469756 - WHITE	2	USDOT# 469756
K30426	17" X 3" USDOT # 76483 - RED	2	USDOT# 76483
K25156	17" X 3" USDOT # 76483 - WHITE	2	USDOT# 76483

- KAG TRACTOR REPLACEMENT DECAL DETAIL

PART #	DESCRIPTION	QUANTITY	IMAGE
K20556	4.5" X 3.25" INSPECTION DECAL	1	
K20563	124.5" X 25.1" DAY CAB DRIVER SIDE	1	
K20564	124.5" X 25.1" DAY CAB PASSENGER SIDE	1	
K20508	1" X 370" SAPPHIRE BLUE STRIPE	1	
K20509	2" X 370" GERANIUM RED STRIPE	1	
K20560	83" X 23" DAY CAB REAR STRIPE	1	
K20651	95" X 30" SLEEPER CAB REAR STRIPE	1	
K20499	28" X 6.78" BLUE AND RED DOOR DECAL AND USDOT *FOR MEXICO ONLY	2	
K20593	28" X 6.78" WHITE AND RED DOOR DECAL AND USDOT *FOR MEXICO ONLY	2	

- KAG TEMPORARY DECALS

PART #	DESCRIPTION	QUANTITY	IMAGE
K25150T	25.5" X 15.7" KAG SPECIALTY PRODUCT GROUP TEMPORARY DECAL	2	
K25152T	29" X 19" KAG FOOD PRODUCTS TEMPORARY DECAL	2	
K25150TM	23" X 14.2" KAG SPECIALTY PRODUCT GROUP TEMPORARY DECAL	2	
K25152TM	23" X 9.7" MACK KAG FOOD PRODUCTS TEMPORARY DECAL	2	
K30484	26.5" X 11" KAG ENERGY TEMPORARY DECAL	2	
K30511T	15" X 28" KAG ENERGY USDOT TEMPORARY DECAL		

- DRY VAN / REEFER APPLICATION DIAGRAM

PASSENGER SIDE

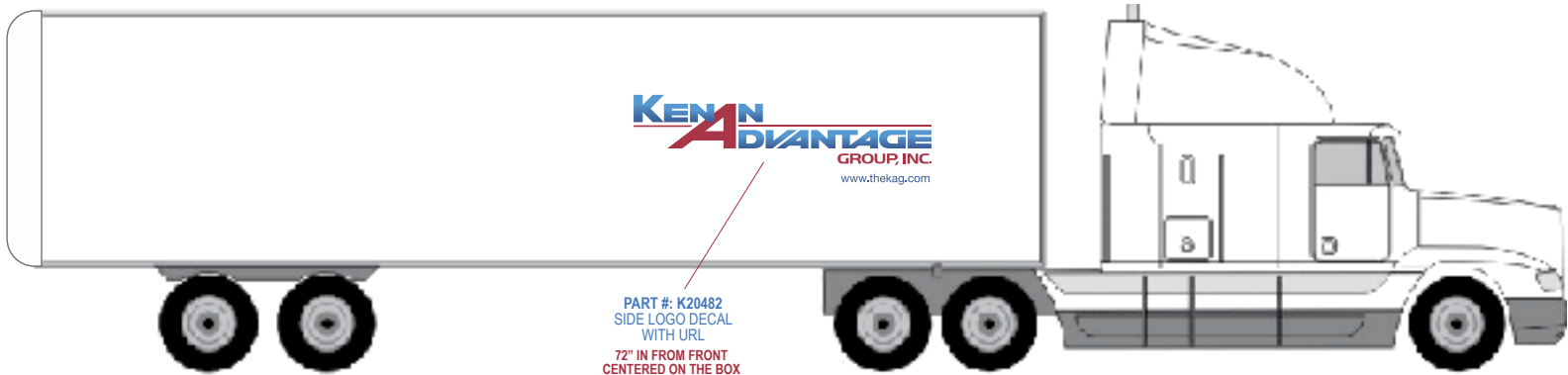

PART #: K20482
SIDE LOGO DECAL
WITH URL
72" IN FROM FRONT
CENTERED ON THE BOX

PART #: K20483
FRONT/REAR LOGO DECAL WITH URL
INSTALL 18 IN. FROM THE TOP
CENTER ON THE BOX

FRONT

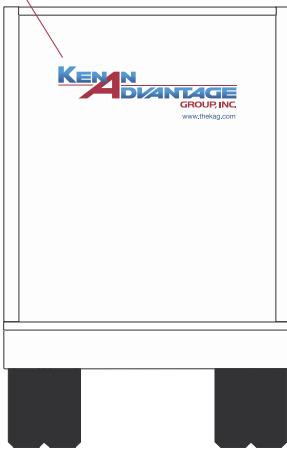

PART #: K20488R
4 IN. TALL BLACK REFLECTIVE
UNIT NUMBERS
INSTALL 2 IN. DOWN FROM TOP
OF DOOR, CENTERED ON
LEFT DOOR.

REAR/BACK

PART #: K20489
REAR LOGO DECAL WITH URL
INSTALL 18 IN. FROM THE TOP
CENTER ON RIGHT DOOR

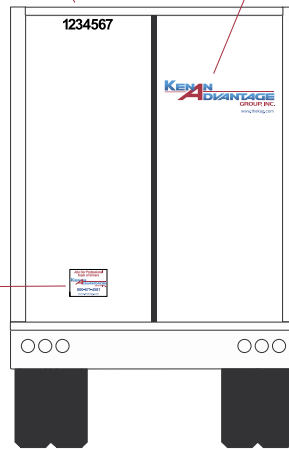

PART #: K20715
REAR HIRING DECAL
Join Our Professional
Team of Drivers
KEN N ADVANTAGE
GROUP, INC.
800-871-4581
www.thekag.com
INSTALL 6 IN. FROM BOTTOM
OF DOOR, CENTERED
ON LEFT DOOR

REEFER

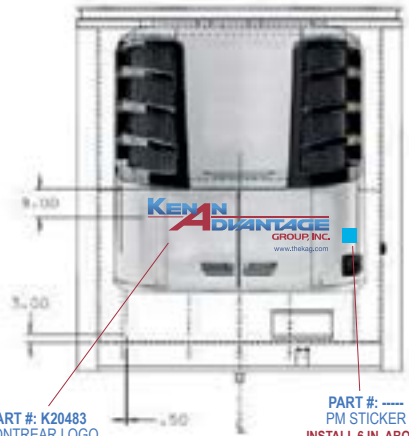

PART #: K20483
FRONTREAR LOGO
DECAL WITH URL

PART #: ----
PM STICKER
INSTALL 6 IN. ABOVE
THE DISPLAY

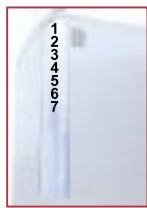

PART #: K20488VR
4 IN. TALL BLACK REFLECTIVE
UNIT NUMBERS
INSTALL ON CORNER RADIUS

PART #: K20482
SIDE LOGO
DECAL WITH URL
72 IN. FROM FRONT
CENTERED ON THE BOX

DRIVER SIDE

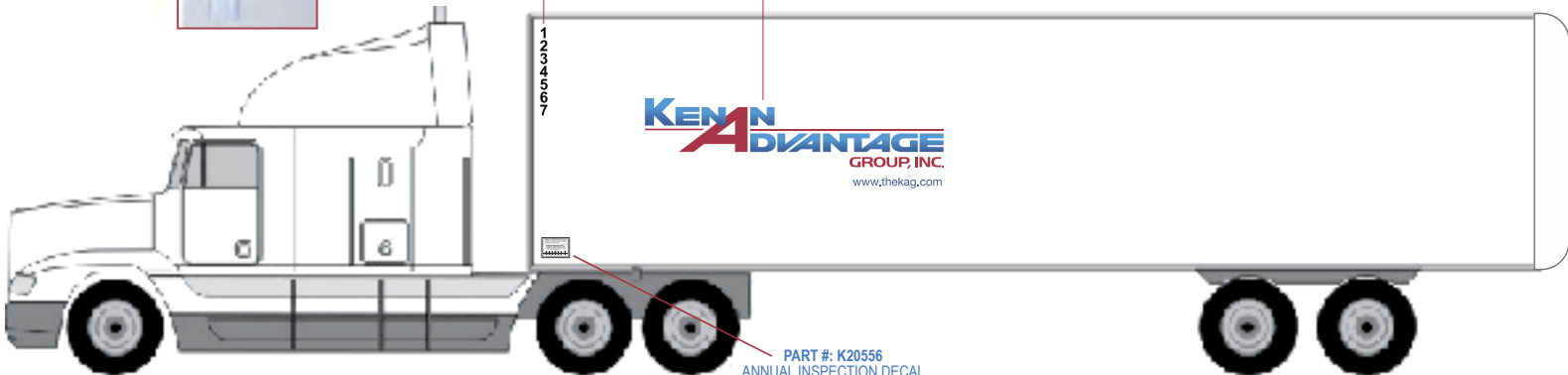





PART #: K20556
ANNUAL INSPECTION DECAL



INSTALL 1 IN. UP FROM THE BOTTOM RAIL
& 1 IN. BACK FROM CORNER RADIUS

- DRY VAN / REEFER - KIT K50204 - \$87.68

PART #	DESCRIPTION	QTY	PRICE	IMAGE
K20488R	4" TALL UNIT NUMBERS HORIZONTAL / BLACK REFLECTIVE	1	\$6.25	1234567
K20482	85.9" X 25.9" SIDE DECAL WITH URL	2	\$22.68	
K20715	16" X 12" REAR HIRING DECAL	1	\$3.40	
K20489	32" X 9.65" REAR DECAL WITH URL	1	\$12.03	
K20488VR	4" TALL UNIT NUMBERS VERTICAL / BLACK REFLECTIVE	1	\$6.25	1 2 3 4 5 6 7
K20483	57.2" X 17.2" FRONT DECAL WITH URL	1	\$14.21	
K20556	4.5" X 3.25"4 ANNUAL INSPECTION DECAL	1	\$.18	

****Decals can be ordered individually if needed.**

- 28 FT. DRY VAN APPLICATION DIAGRAM

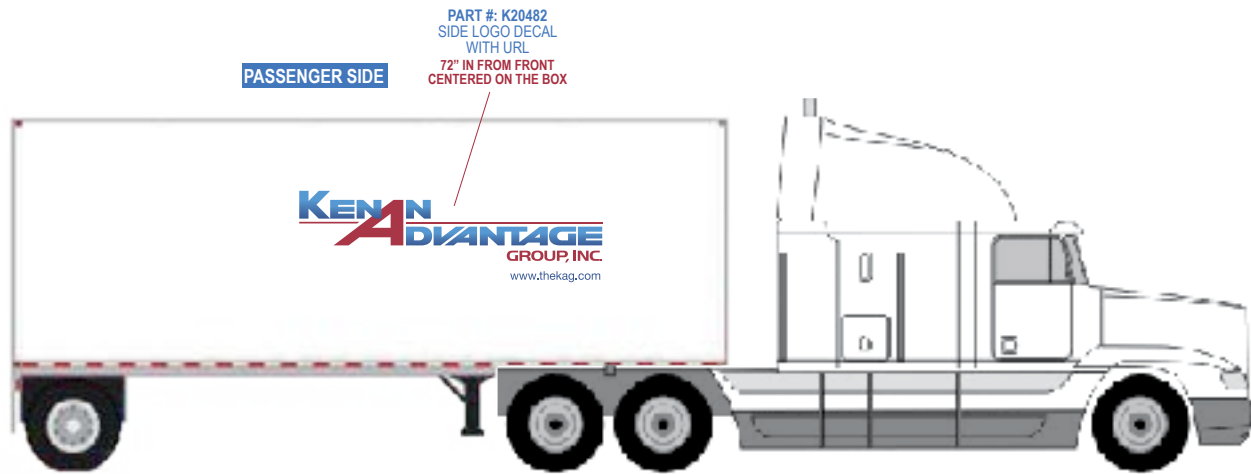

PART #: K20483
REAR LOGO DECAL
WITH URL
INSTALL 18" FROM THE
TOP CENTERED
ON THE BOX

FRONT

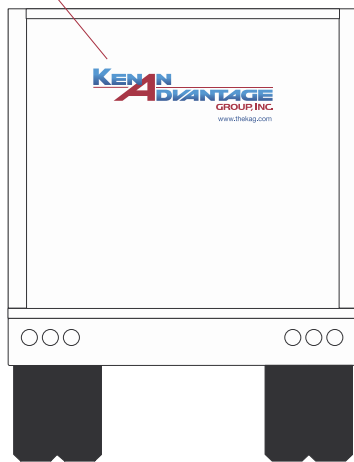

PART #: K20488R
4 IN. TALL BLACK
REFLECTIVE
UNIT NUMBERS
INSTALL 2" DOWN FROM TOP

REAR/BACK

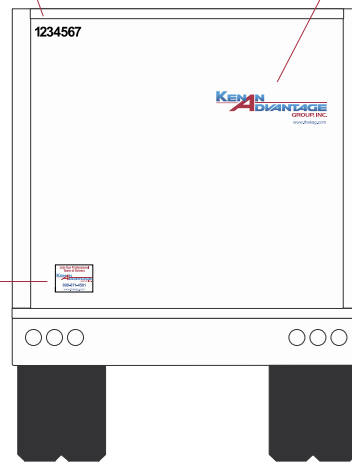

PART #: K20489
REAR LOGO DECAL
WITH URL
INSTALL 18" DOWN FROM TOP

PART #: K20715
REAR HIRING
DECAL

Join Our Professional
Team of Drivers

KEN ADVANTAGE GROUP, INC.
800-871-4581
www.thekag.com

INSTALL 6" FROM BOTTOM OF
DOOR CENTERED ON
LEFT DOOR



PART #: K20488VR
4 IN. TALL BLACK
REFLECTIVE
UNIT NUMBERS
INSTALL ON
CORNER RADIUS

PART #: K20482
SIDE LOGO DECAL
WITH URL
72" IN FROM FRONT
CENTERED ON THE BOX

DRIVER SIDE

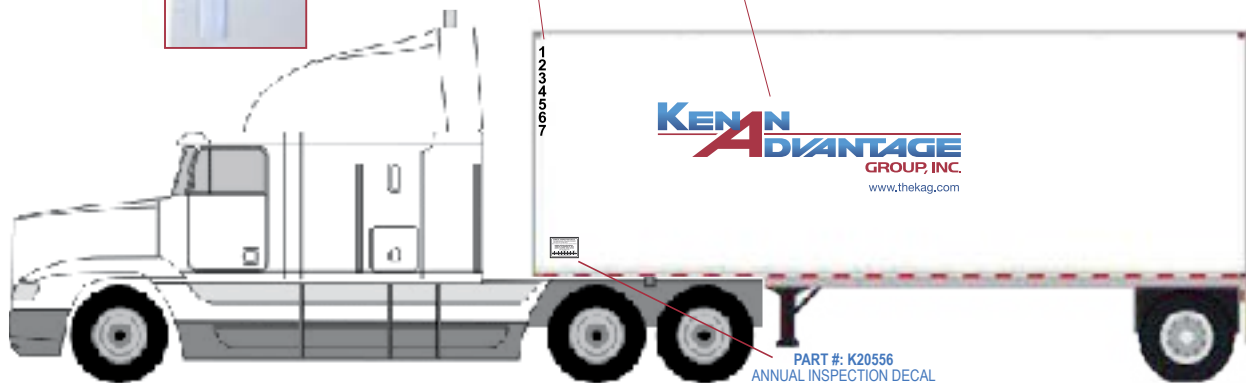

ANNUAL INSPECTION DECAL
This decal may be used as inspection or maintenance
with OSHA 1910.133(b)(1) and 1910.133(b)(2)

NAME AND ADDRESS OF EMPLOYER (OPTIONAL) TO BE PRINTED
KENAN ADVANTAGE GROUP
4380 MT. PLEASANT ST., N.W.
NORTH CANTON, OHIO 44705





DATE OF INSPECTION
MONTH YEAR
JAN FEB MAR APR MAY JUN JUL AUG SEP OCT NOV DEC 20 21

INSPECTOR (SEE INSTRUCTIONS) 22 23

www.thekag.com or call 800-871-4581

INSTALL 1" UP FROM THE BOTTOM RAIL
& 1" BACK FROM CORNER RADIUS

- 28 FT. DRY VAN - KIT K50205 - \$87.68

PART #	DESCRIPTION	QTY	PRICE	IMAGE
K20488R	4" TALL UNIT NUMBERS HORIZONTAL / BLACK REFLECTIVE	1	\$6.25	1234567
K20482	85.9" X 25.9" SIDE DECAL WITH URL	2	\$22.68	
K20715	16" X 12" REAR HIRING DECAL	1	\$3.40	
K20489	32" X 9.65" REAR DECAL WITH URL	1	\$12.03	
K20488VR	4" TALL UNIT NUMBERS VERTICAL / BLACK REFLECTIVE	1	\$6.25	1 2 3 4 5 6 7
K20483	57.2" X 17.2" FRONT DECAL WITH URL	1	\$14.21	
K20556	4.5" X 3.25" ANNUAL INSPECTION DECAL	1	\$.18	

****Decals can be ordered individually if needed.**

- DRY VAN / REEFER (FOOD GRADE ONLY) APPLICATION DIAGRAM

PASSENGER SIDE



PART #: K20482
SIDE LOGO DECAL
WITH URL
72" IN FROM FRONT
CENTERED ON THE BOX

PART #: K20483
FRONT/REAR LOGO DECAL WITH URL
INSTALL 18 IN. FROM THE TOP
CENTER ON THE BOX

FRONT

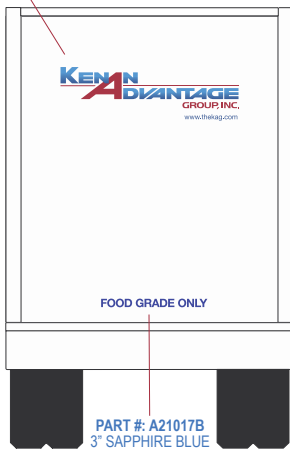

PART #: A21017B
3" SAPHIRE BLUE
"FOOD GRADE ONLY"
INSTALL 6 IN. FROM BOTTOM RAIL
CENTER ON REAR

PART #: K20488R
4 IN. TALL BLACK
UNIT NUMBERS
INSTALL 2 IN. DOWN FROM TOP
OF DOOR, CENTERED ON
LEFT DOOR.

PART #: K20489
REAR LOGO DECAL WITH URL
INSTALL 18 IN. FROM THE TOP
CENTER ON THE BOX

REAR/BACK

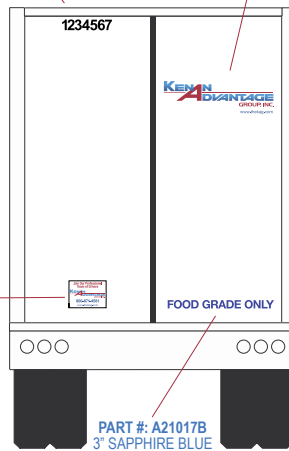

PART #: A21017B
3" SAPHIRE BLUE
"FOOD GRADE ONLY"
INSTALL 6 IN. FROM BOTTOM RAIL
CENTER ON REAR

PART #: K20715
REAR HIRING DECAL
Join Our Professional
Team of Drivers
KENN ADVANTAGE GROUP, INC.
800-674-4581
www.thekag.com

INSTALL 6 IN. FROM BOTTOM
OF DOOR, CENTERED
ON LEFT DOOR

PART #: K20483
FRONT/REAR LOGO
DECAL WITH URL

REEFER

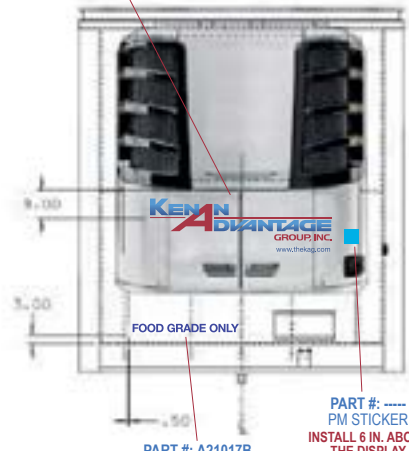

FOOD GRADE ONLY

PART #: ----
PM STICKER
INSTALL 6 IN. ABOVE
THE DISPLAY

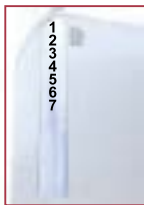

PART #: K20488VR
4 IN. TALL BLACK
UNIT NUMBERS
INSTALL ON CORNER RADIUS

PART #: K20482
SIDE LOGO
DECAL WITH URL
72 IN. FROM FRONT
CENTERED ON THE BOX

DRIVER SIDE

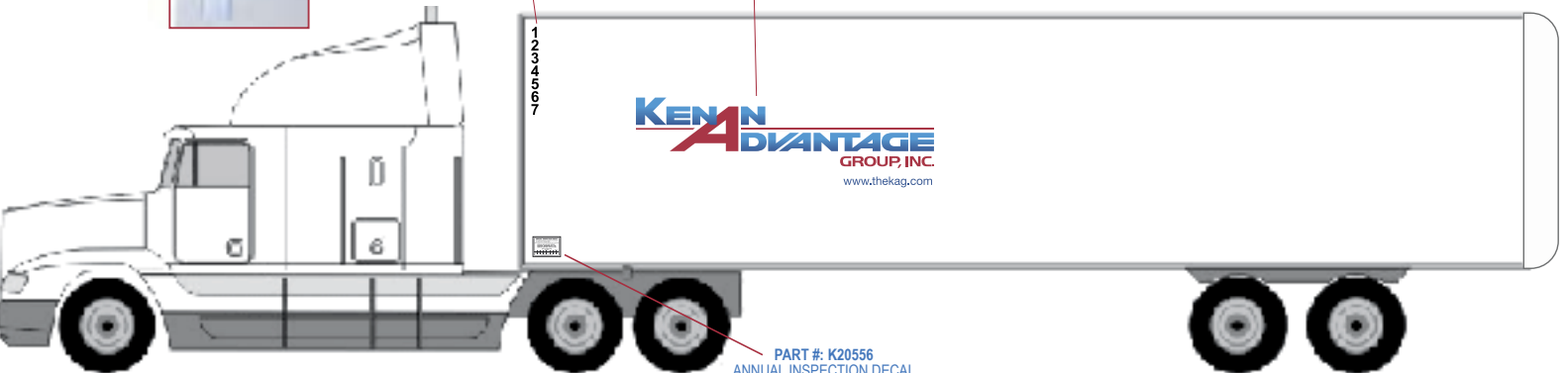





PART #: K20556
ANNUAL INSPECTION DECAL



INSTALL 1 IN. UP FROM THE BOTTOM RAIL
& 1 IN. BACK FROM CORNER RADIUS

- DRY VAN / REEFER (FOOD GRADE ONLY) - KIT K50200 - \$98.26

PART #	DESCRIPTION	QTY	PRICE	IMAGE
K20488R	4" TALL UNIT NUMBERS HORIZONTAL / BLACK REFLECTIVE	1	\$6.25	1234567
K20482	85.9" X 25.9" SIDE DECAL WITH URL	2	\$22.68	
K20715	16" X 12" REAR HIRING DECAL	1	\$3.40	
K20489	32" X 9.65" REAR DECAL WITH URL	1	\$12.03	
K20488VR	4" TALL UNIT NUMBERS VERTICAL / BLACK REFLECTIVE	1	\$6.25	1 2 3 4 5 6 7
K20483	57.2" X 17.2" FRONT DECAL WITH URL	1	\$14.21	
A21017B	3" TALL SAPPHIRE BLUE "FOOD GRADE ONLY"	2	\$5.29	FOOD GRADE ONLY
K20556	4.5" X 3.25"4 ANNUAL INSPECTION DECAL	1	\$.18	

****Decals can be ordered individually if needed.**

- FOOD GRADE TRAILER / TANKER APPLICATION DIAGRAM

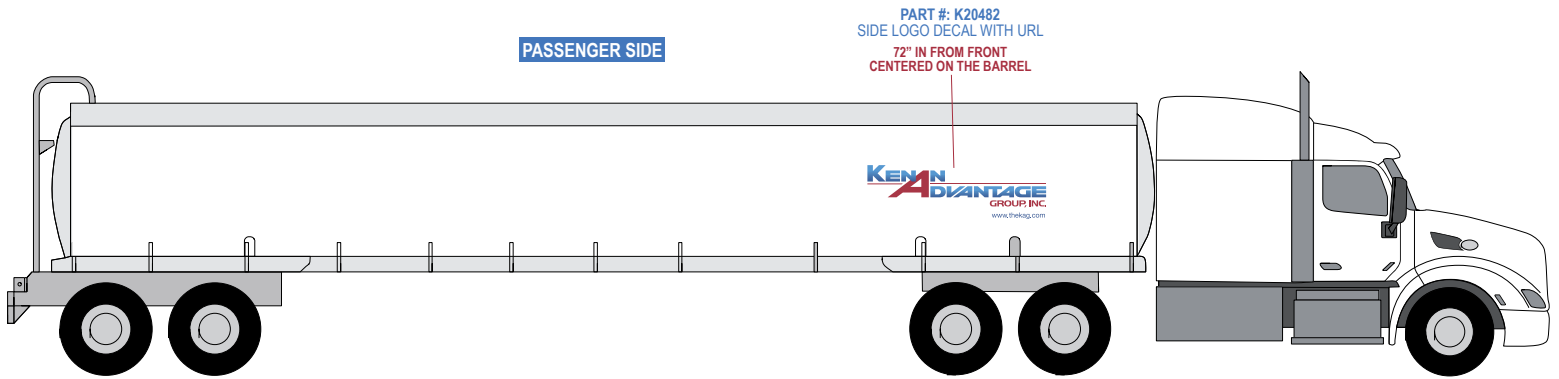

PART #: K20483
FRONT/REAR LOGO DECAL WITH URL
INSTALL 18 IN. FROM THE TOP
CENTER ON THE BARREL

FRONT

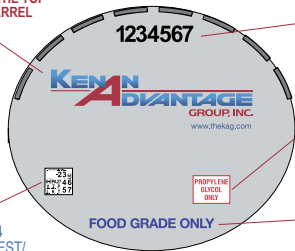

PART #: K20488R
4 IN. TALL BLACK REFLECTIVE UNIT NUMBERS
INSTALL 6\"/>

REAR/BACK

PART #: K20483
FRONT/REAR LOGO DECAL WITH URL
INSTALL 18 IN. FROM THE TOP
CENTER ON THE BARREL

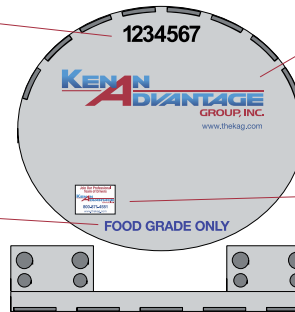

PART #: K20715
REAR HIRING DECAL
INSTALL 6\"/>

PART #-1294
CARGO TANK TEST/
INSPECTION DECAL



INSTALL ON PASSENGER SIDE
6\"/>



PART #: K20482
SIDE LOGO DECAL WITH URL
72\"/>

DRIVER SIDE

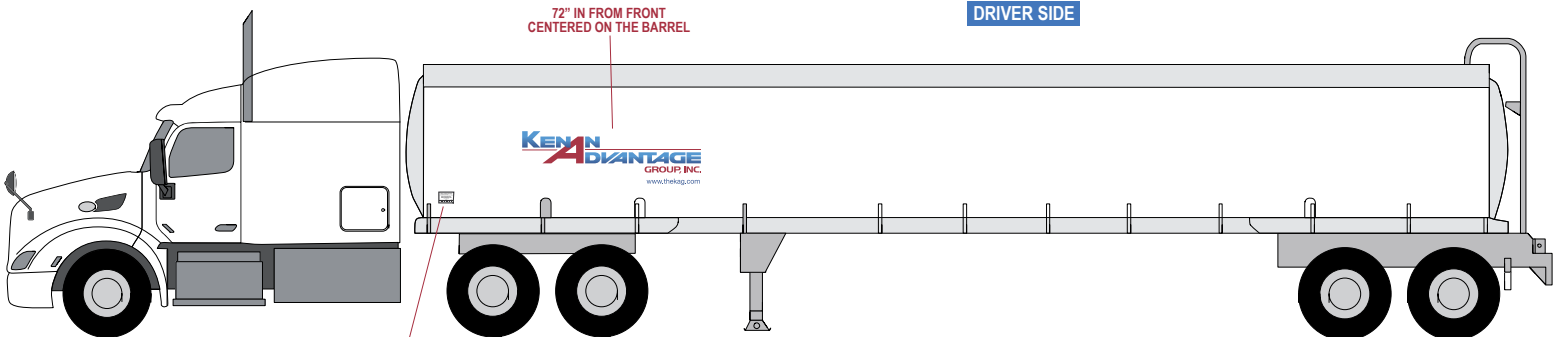





PART #: K20556
ANNUAL INSPECTION DECAL



INSTALL 2 IN. BACK FROM SEAM.
RIGHT ABOVE THE BRACKET

- FOOD GRADE TRAILER / TANKER - KIT K50202 - \$108.38

PART #	DESCRIPTION	QTY	PRICE	IMAGE
K20488R	4" TALL UNIT NUMBERS HORIZONTAL / BLACK REFLECTIVE	2	\$6.25	1234567
K20482	85.9" X 25.9" SIDE DECAL WITH URL	2	\$22.68	
K20825	6.75" X 5.125" PROPYLENE GLYCOL ONLY	1	\$2.18	PROPYLENE GLYCOL ONLY
K20715	16" X 12" REAR HIRING DECAL	1	\$3.40	
A21017B	3" TALL SAPPHIRE BLUE "FOOD GRADE ONLY"	2	\$5.29	FOOD GRADE ONLY
K20483	57.2" X 17.2" FRONT DECAL WITH URL	2	\$14.21	
K20556	4.5" X 3.25"4 ANNUAL INSPECTION DECAL	1	\$.18	
K1294	CARGO TANK TEST / INSPECTION DECAL	1	\$3.42	
K20484	21.75" X 2.125" THIS VEHICLE STOPS DECAL	1	\$1.17	THIS VEHICLE STOPS AT
K20485	22.75" X 2.125" ALL RAILROAD DECAL	1	\$1.17	ALL RAILROAD CROSSINGS

****Decals can be ordered individually if needed.**

- CRUDE TRAILER / TANKER APPLICATION DIAGRAM

*Crude trailers or other trailers that have side bolsters that interfere with side logo will only receive a rear decal.

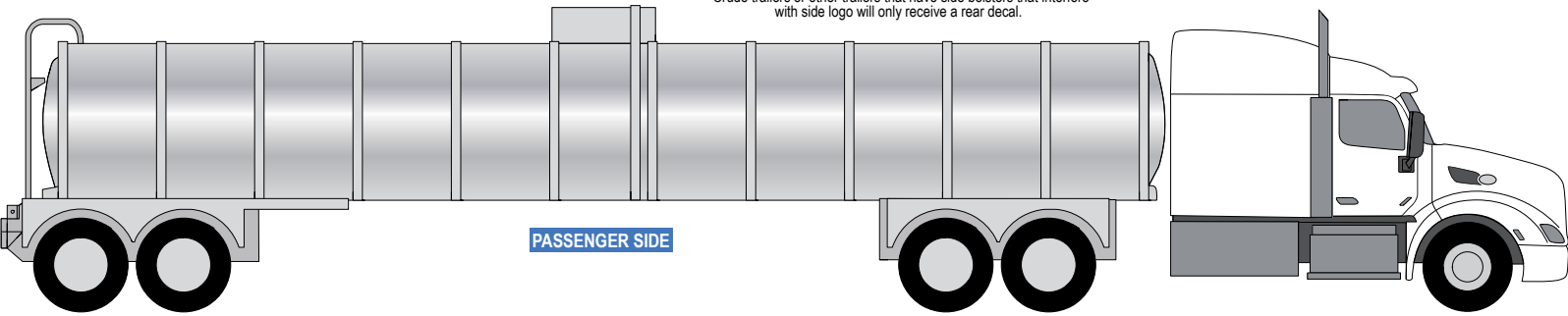

PART #: K20483
FRONT/REAR LOGO DECAL WITH URL
INSTALL 18 IN. FROM THE TOP
CENTER ON THE BARREL

FRONT

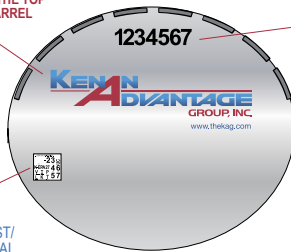

PART #: K1294
CARGO TANK TEST/
INSPECTION DECAL



INSTALL ON PASSENGER SIDE
6" FROM THE BOTTOM AND
6" IN FRONT LEFT SIDE

PART #: K20488R
4 IN. TALL BLACK REFLECTIVE UNIT NUMBERS
INSTALL 6" FROM THE TOP AND
CENTERED ON THE BARREL

REAR/BACK

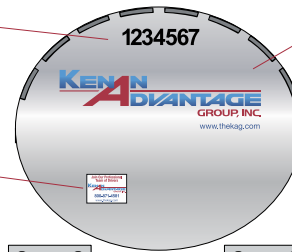

PART #: K20715
REAR HIRING DECAL
INSTALL 6" IN FROM LEFT SIDE
OF TANK AND 6" FROM BOTTOM
OF TANK SEAM



PART #: K20483
FRONT/REAR LOGO DECAL WITH URL
INSTALL 18 IN. FROM THE TOP
CENTER ON THE BARREL



THIS VEHICLE STOPS AT

PART #: K20484
VEHICLE STOP DECAL
INSTALL IN THE CENTER OF THE REAR

ALL RAILROAD CROSSINGS

PART #: K20485
RAILROAD CROSSING DECAL
INSTALL IN THE CENTER OF THE REAR

*Crude trailers or other trailers that have side bolsters that interfere with side logo will only receive a rear decal.

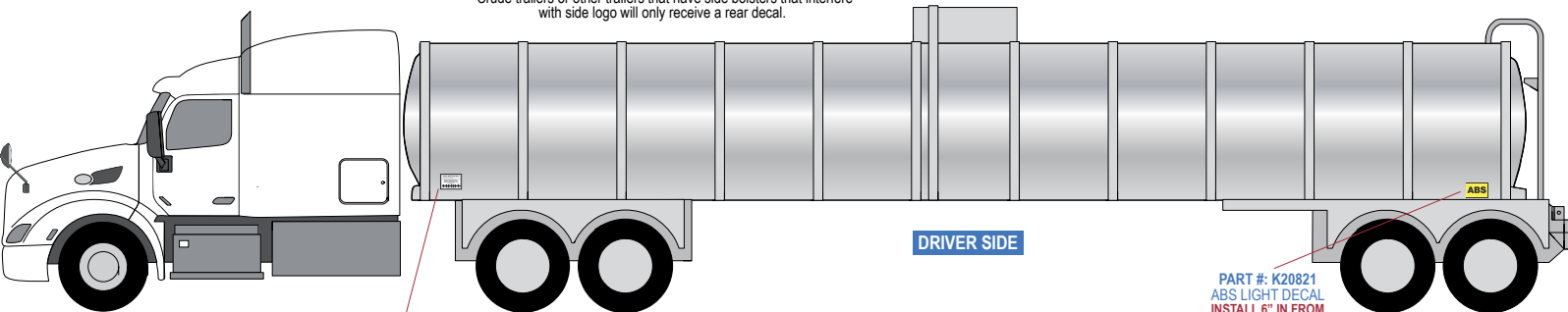







PART #: K20556
ANNUAL INSPECTION DECAL



INSTALL 2 IN. BACK FROM SEAM.
RIGHT ABOVE THE BRACKET

PART #: K20821
ABS LIGHT DECAL
INSTALL 6" IN FROM
THE REAR SEAM

- CRUDE TRAILER / TANKER - KIT K50501 - \$50.26

PART #	DESCRIPTION	QTY	PRICE	IMAGE
K20488R	4" TALL UNIT NUMBERS HORIZONTAL / BLACK REFLECTIVE	2	\$6.25	1234567
K20483	57.2" X 17.2" FRONT DECAL WITH URL	2	\$14.21	
K20715	16" X 12" REAR HIRING DECAL	1	\$3.40	
K20484	21.75" X 2.125" THIS VEHICLE STOPS DECAL	1	\$1.17	
K20485	22.75" X 2.125" ALL RAILROAD DECAL	1	\$1.17	
K20556	4.5" X 3.25" ANNUAL INSPECTION DECAL	1	\$.18	
K1294	CARGO TANK TEST/INSPECTION DECAL	1	\$3.42	

**Decals can be ordered individually if needed.

- EXPOSED RINGS - TRAILER/TANKER APPLICATION DIAGRAM

TRAILER/TANKER WITH ENHANCED ID LIGHT BRACKET

*Crude trailers or other trailers that have side bolsters that interfere with side logo will only receive a rear decal.

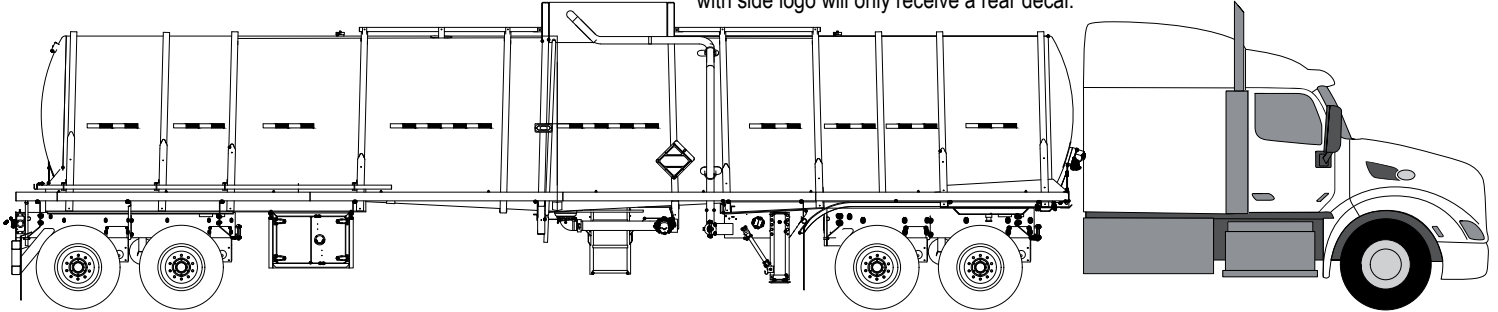

PASSENGER SIDE

FRONT

PART #: K20483
FRONT/REAR LOGO DECAL WITH URL
INSTALL 18 IN. FROM THE TOP
CENTER ON THE BARREL

PART #: K1294
CARGO TANK TEST/
INSPECTION DECAL



INSTALL ON PASSENGER SIDE
6" FROM THE BOTTOM AND
6" IN FRONT LEFT SIDE

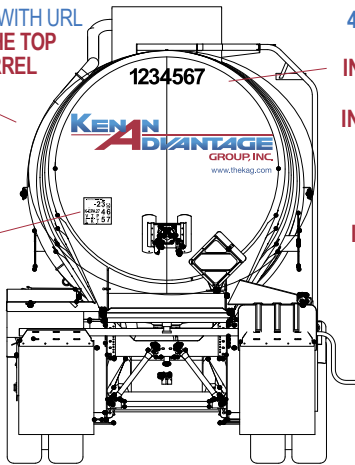

REAR/BACK

PART #: K20488R
4 IN. TALL BLACK REFLECTIVE
UNIT NUMBERS
INSTALL 6" FROM THE TOP AND
CENTERED ON THE BARREL
INSTALL 10" FROM THE TOP AND
CENTERED ON THE BARREL

PART #: K20715
REAR HIRING DECAL
INSTALL 6" IN THE CENTER
6" ABOVE BOTTOM SEAM



PART #: K20483
FRONT/REAR LOGO DECAL WITH URL
INSTALL 25 IN. FROM THE TOP
CENTER ON THE BARREL

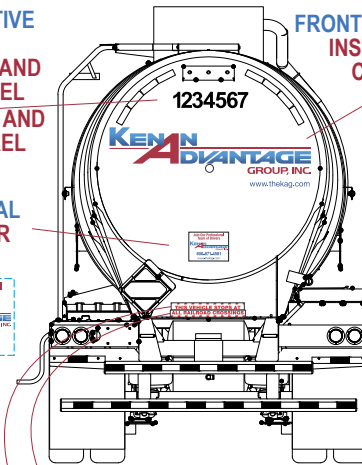

PART #: K20484
VEHICLE STOP DECAL
INSTALL FLUSH WITH BOTTOM OF
CROSSMEMBER, CENTERED



PART #: K20485
RAILROAD CROSSING DECAL
INSTALL FLUSH WITH BOTTOM OF
CROSSMEMBER, BELOW K20484, CENTERED

*Crude trailers or other trailers that have side bolsters that interfere with side logo will only receive a rear decal.

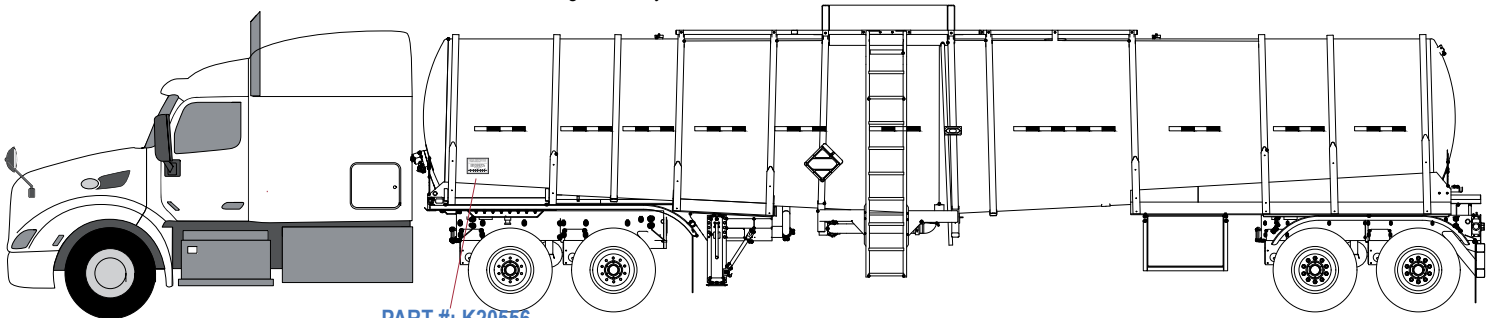

DRIVER SIDE







PART #: K20556
ANNUAL INSPECTION DECAL



INSTALL 2 IN. BACK FROM SEAM.
RIGHT ABOVE THE BRACKET

- EXPOSED RINGS - TRAILER/TANKER KIT LIST - KIT 50511 - \$50.26

TRAILER/TANKER WITH ENHANCED ID LIGHT BRACKET

PART #	DESCRIPTION	QTY	PRICE	IMAGE
K20488R	4" TALL UNIT NUMBERS HORIZONTAL / BLACK REFLECTIVE	2	\$6.25	1234567
K20483	57.2" X 17.2" FRONT DECAL WITH URL	2	\$14.21	
K20715	16" X 12" REAR HIRING DECAL	1	\$3.40	
K20484	21.75" X 2.125" THIS VEHICLE STOPS DECAL	1	\$1.17	
K20485	22.75" X 2.125" ALL RAILROAD DECAL	1	\$1.17	
K20556	4.5" X 3.25"4 ANNUAL INSPECTION DECAL	1	\$1.18	
K1294	CARGO TANK TEST/INSPECTION DECAL	1	\$3.42	

****Decals can be ordered individually if needed.**

- ASPHALT TRAILER / TANKER APPLICATION DIAGRAM

*Crude trailers or other trailers that have side bolsters that interfere with side logo will only receive a rear decal.

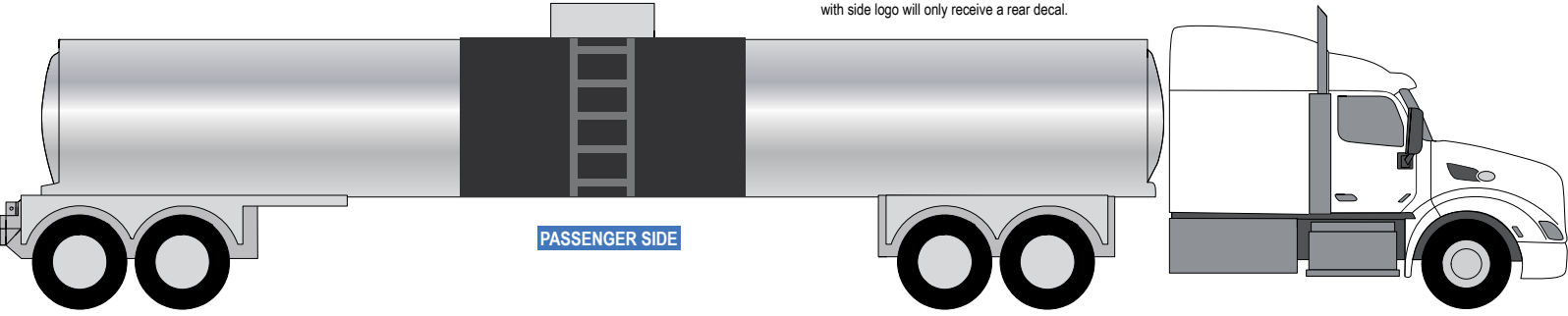

PART #: K20483
FRONT/REAR LOGO DECAL WITH URL
INSTALL 18 IN. FROM THE TOP
CENTER ON THE BARREL

FRONT

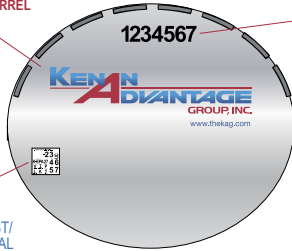

PART #: K20488R
4 IN. TALL BLACK REFLECTIVE UNIT NUMBERS
INSTALL 6" FROM THE TOP AND
CENTERED ON THE BARREL

REAR/BACK

PART #: K20483
FRONT/REAR LOGO DECAL WITH URL
INSTALL 18 IN. FROM THE TOP
CENTER ON THE BARREL

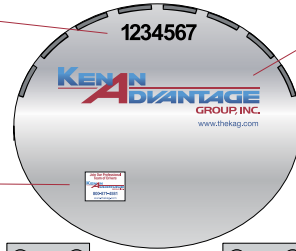

PART #: K20715
REAR HIRING DECAL
INSTALL 6" IN FROM LEFT SIDE
OF TANK AND 6" FROM BOTTOM
OF TANK SEAM



PART #: K1294
CARGO TANK TEST/
INSPECTION DECAL



INSTALL ON PASSENGER SIDE
6" FROM THE BOTTOM AND
6" IN FRONT LEFT SIDE

PART #: K20484
VEHICLE STOP DECAL
INSTALL IN THE CENTER OF THE REAR

PART #: K20485
RAILROAD CROSSING DECAL
INSTALL IN THE CENTER OF THE REAR

THIS VEHICLE STOPS AT
ALL RAILROAD CROSSINGS

*Crude trailers or other trailers that have side bolsters that interfere with side logo will only receive a rear decal.

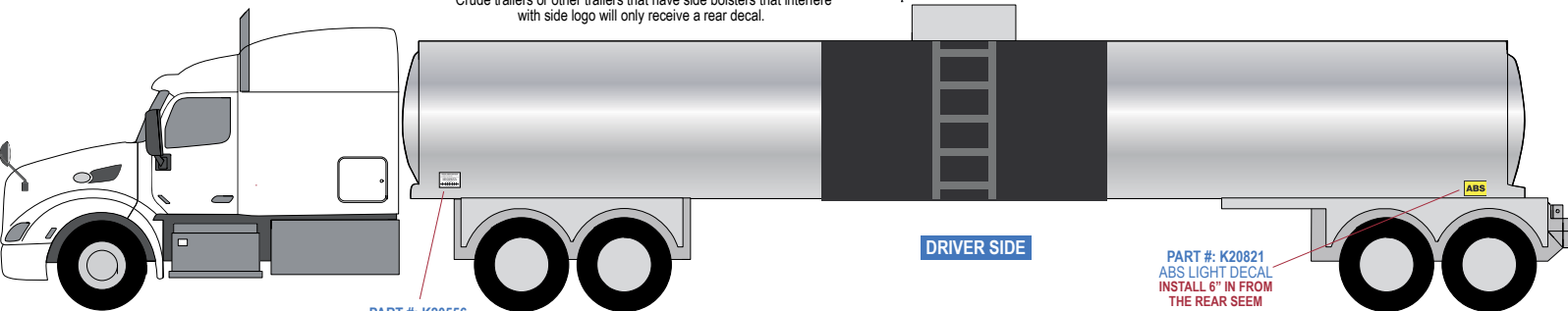







PART #: K20556
ANNUAL INSPECTION DECAL



INSTALL 2 IN. BACK FROM SEAM.
RIGHT ABOVE THE BRACKET

PART #: K20821
ABS LIGHT DECAL
INSTALL 6" IN FROM
THE REAR SEAM

- ASPHALT TRAILER / TANKER - KIT K50509 - \$50.26

PART #	DESCRIPTION	QTY	PRICE	IMAGE
K20488R	4" TALL UNIT NUMBERS HORIZONTAL / BLACK REFLECTIVE	2	\$6.25	1234567
K20483	57.2" X 17.2" FRONT DECAL WITH URL	2	\$14.21	
K20715	16" X 12" REAR HIRING DECAL	1	\$3.40	
K20484	21.75" X 2.125" THIS VEHICLE STOPS DECAL	1	\$1.17	
K20485	22.75" X 2.125" ALL RAILROAD DECAL	1	\$1.17	
K20556	4.5" X 3.25"4 ANNUAL INSPECTION DECAL	1	\$.18	
K1294	CARGO TANK TEST/INSPECTION DECAL	1	\$3.42	

**Decals can be ordered individually if needed.

- FUEL TANKER APPLICATION DIAGRAM

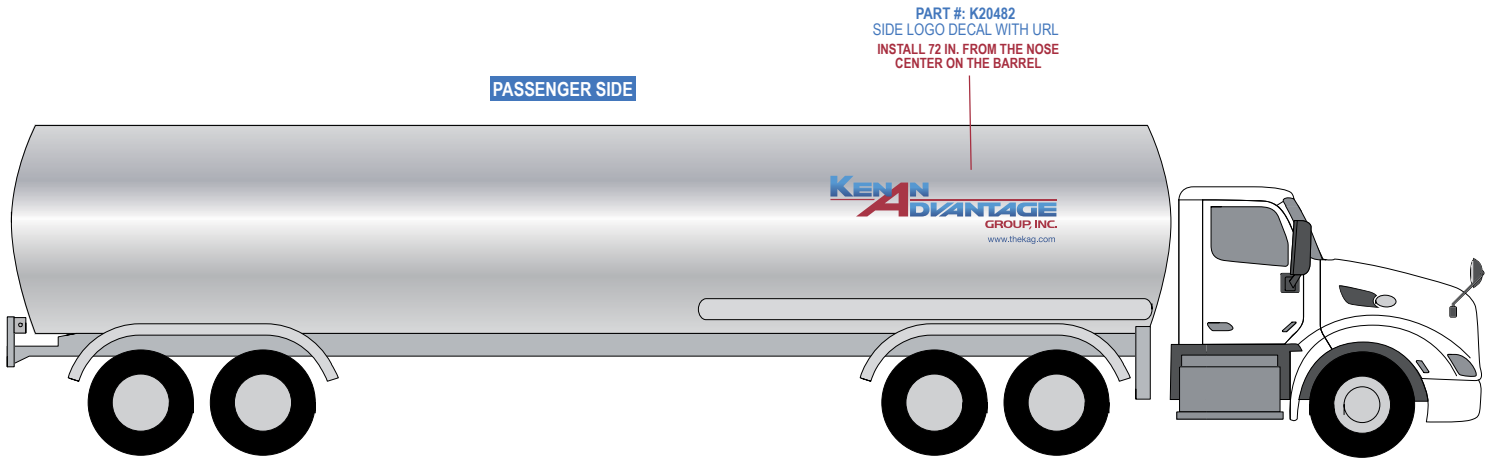

PASSENGER SIDE

PART #: K20482
SIDE LOGO DECAL WITH URL
INSTALL 72 IN. FROM THE NOSE
CENTER ON THE BARREL

PART #: K20483
FRONT/REAR LOGO DECAL WITH URL
INSTALL 18 IN. FROM THE TOP
CENTER ON THE BARREL

FRONT

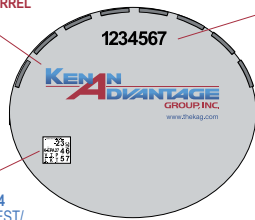

PART #: K20488R
4 IN. TALL BLACK REFLECTIVE UNIT NUMBERS
INSTALL 6" FROM THE TOP AND
CENTERED ON THE BARREL

REAR/BACK

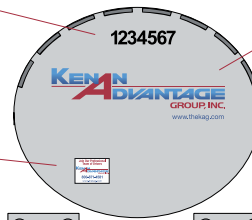

PART #: K20483
FRONT/REAR LOGO DECAL WITH URL
INSTALL 18 IN. FROM THE TOP
CENTER ON THE BARREL

PART #: K1294
CARGO TANK TEST/
INSPECTION DECAL



INSTALL ON PASSENGER SIDE
6" FROM THE BOTTOM AND
6" IN FRONT LEFT SIDE

PART #: K20715
REAR HIRING DECAL
INSTALL 6" IN FROM LEFT SIDE
OF TANK AND 6" FROM BOTTOM
OF TANK SEAM



PART #: K20484
VEHICLE STOP DECAL
INSTALL IN THE CENTER OF THE REAR

PART #: K20485
RAILROAD CROSSING DECAL
INSTALL IN THE CENTER OF THE REAR

PART #: K20482
SIDE LOGO DECAL WITH URL
INSTALL 72 IN. FROM THE NOSE
CENTER ON THE BARREL

DRIVER SIDE

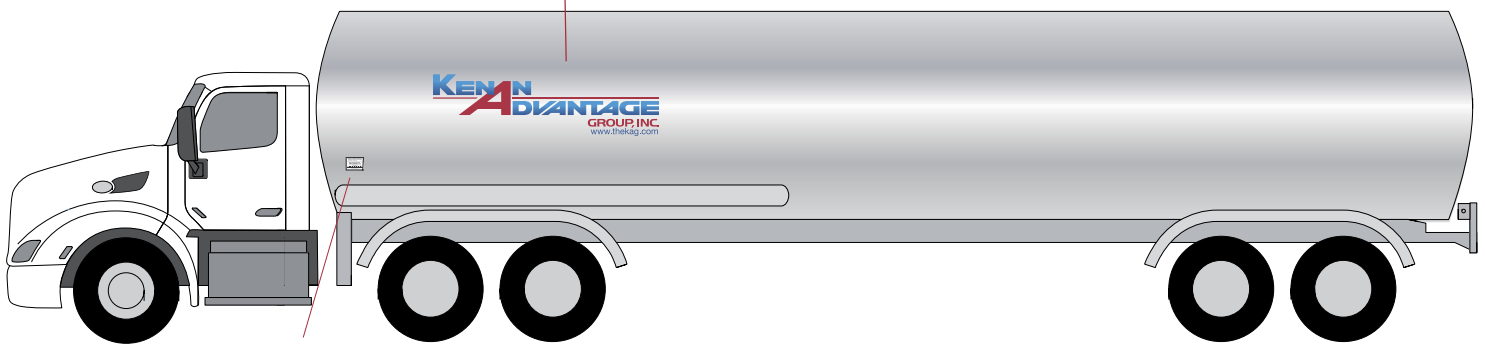







PART #: K20556
ANNUAL INSPECTION DECAL



INSTALL 2 IN. BACK FROM SEAM.
RIGHT ABOVE THE BRACKET

- FUEL TANKER - KIT K50507 - \$95.62

PART #	DESCRIPTION	QTY	PRICE	IMAGE
K20488R	4" TALL UNIT NUMBERS HORIZONTAL / BLACK REFLECTIVE	2	\$6.25	1234567
K20482	85.9" X 25.9" SIDE DECAL WITH URL	2	\$22.68	
K20715	16" X 12" REAR HIRING DECAL	1	\$3.40	
K20484	21.75" X 2.125" THIS VEHICLE STOPS DECAL	1	\$1.17	
K20485	22.75" X 2.125" ALL RAILROAD DECAL	1	\$1.17	
K20483	57.2" X 17.2" FRONT DECAL WITH URL	2	\$14.21	
K20556	4.5" X 3.25" ANNUAL INSPECTION DECAL	1	\$1.18	
K1294	CARGO TANK TEST/INSPECTION DECAL	1	\$3.42	

**Decals can be ordered individually if needed.

- TRUCK TANK & PULL TANK APPLICATION DIAGRAM

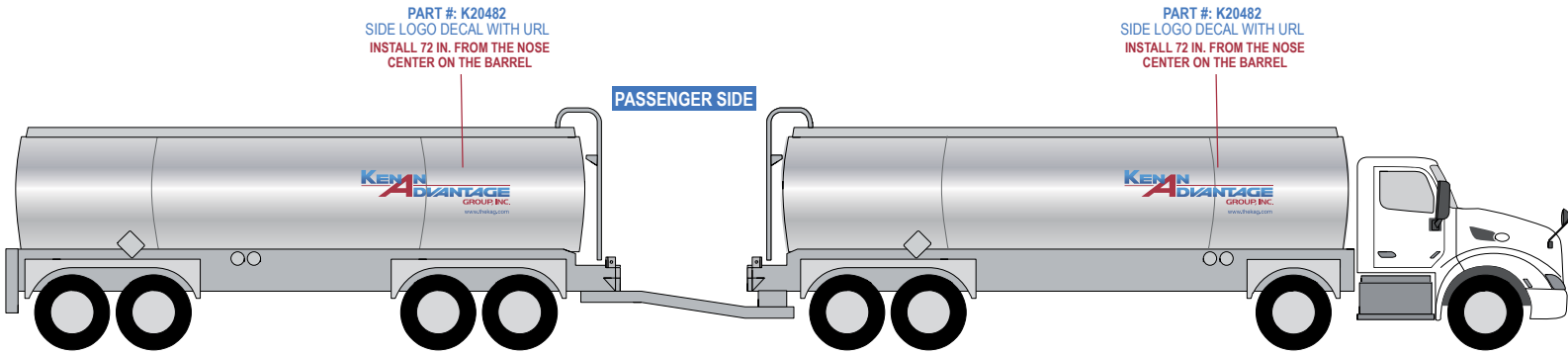

*PULL TANK AND TRUCK TANK HAVE DIFFERENT UNIT NUMBERS

PART #:K1294
CARGO TANK TEST/
INSPECTION DECAL



INSTALL ON PASSENGER SIDE
6" FROM THE BOTTOM AND
6" IN FRONT LEFT SIDE

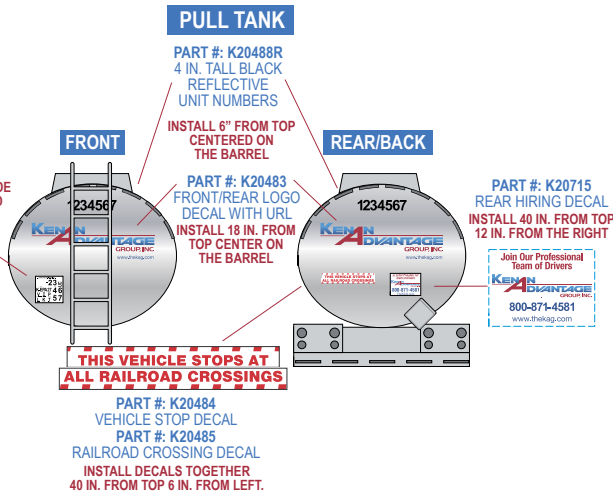

TRUCK TANK

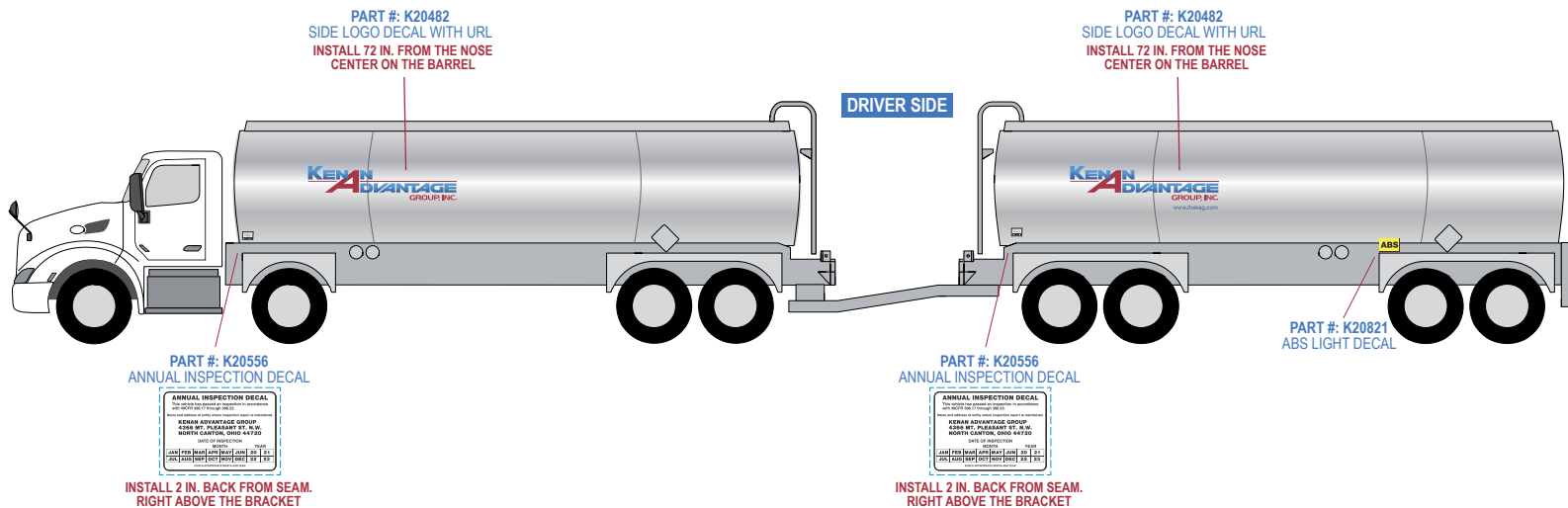
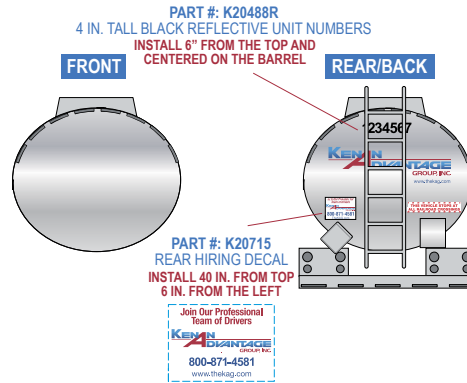

- TRUCK TANK & PULL TANK KIT 50500 - \$167.36

PART #	DESCRIPTION	QTY	PRICE	IMAGE
K20488R	4" TALL UNIT NUMBERS HORIZONTAL / BLACK REFLECTIVE	3	\$6.25	
K20482	85.9" X 25.9" SIDE DECAL WITH URL	4	\$22.68	
K20483	57.2" X 17.2" FRONT DECAL WITH URL	3	\$14.21	
K20715	16" X 12" REAR HIRING DECAL	2	\$3.40	
K20484	21.75" X 2.125" THIS VEHICLE STOPS DECAL	2	\$1.17	
K20485	22.75" X 2.125" ALL RAILROAD DECAL	2	\$1.17	
K20556	4.5" X 3.25"4 ANNUAL INSPECTION DECAL	2	\$1.18	
K1294	CARGO TANK TEST/INSPECTION DECAL	1	\$3.42	

****Decals can be ordered individually if needed.**

- MERCHANT GAS GROUP TANKER APPLICATION DIAGRAM

PASSENGER SIDE

PART #: K20482
SIDE LOGO DECAL WITH URL
INSTALL 72 IN. FROM THE NOSE
CENTER ON THE BARREL

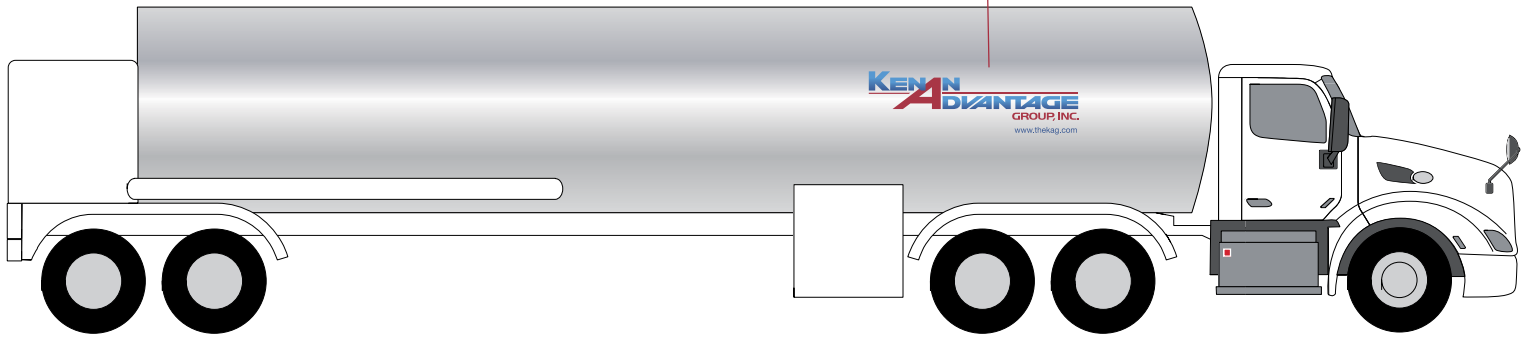

FRONT

PART #: K20488R
4 IN. TALL BLACK
REFLECTIVE
UNIT NUMBERS
INSTALL 6" FROM TOP
CENTERED ON
THE BARREL

1234567

PART #: K1294
CARGO TANK TEST/
INSPECTION DECAL



INSTALL ON PASSENGER SIDE
6" FROM THE BOTTOM AND
6" IN FRONT LEFT SIDE

REAR/BACK

PART #: K20488R
4 IN. TALL BLACK
REFLECTIVE
UNIT NUMBERS
INSTALL 6" FROM THE TOP AND
CENTERED ON THE BARREL

1234567

PART #: K20715
REAR HIRING DECAL
INSTALL 40 IN. FROM TOP
6 IN. FROM THE RIGHT



PART #: K20484
VEHICLE STOP DECAL
INSTALL IN THE CENTER OF THE REAR

PART #: K20485
RAILROAD CROSSING DECAL
INSTALL IN THE CENTER OF THE REAR

DRIVER SIDE

PART #: K20482
SIDE LOGO DECAL WITH URL
INSTALL 72 IN. FROM THE NOSE
CENTER ON THE BARREL

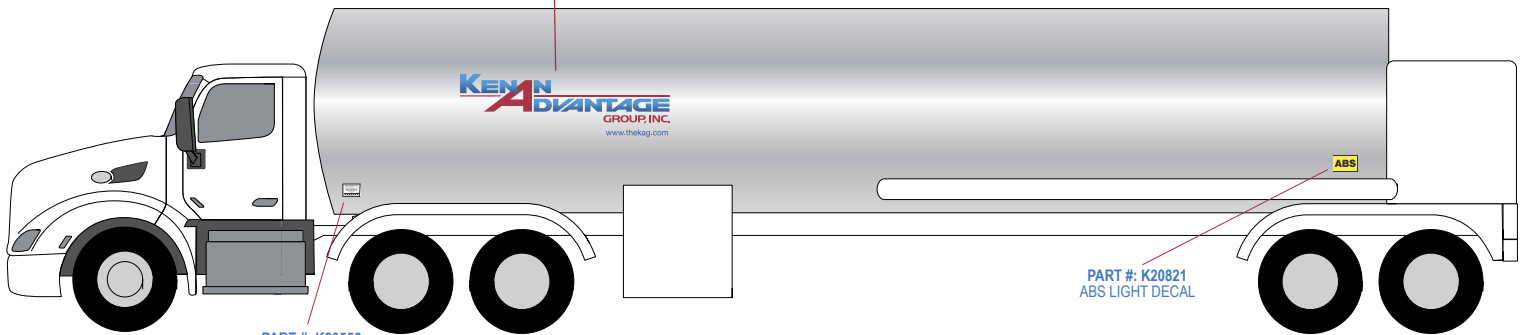

PART #: K20821
ABS LIGHT DECAL

PART #: K20556
ANNUAL INSPECTION DECAL



INSTALL 2 IN. BACK FROM SEAM.
RIGHT ABOVE THE BRACKET

- MERCHANT GAS GROUP TANKER - KIT K55148 - \$67.92

PART #	DESCRIPTION	QTY	PRICE	IMAGE
K20488R	4" TALL UNIT NUMBERS HORIZONTAL / BLACK REFLECTIVE	2	\$6.25	
K20482	85.9" X 25.9" SIDE DECAL WITH URL	2	\$22.68	
K20715	16" X 12" REAR HIRING DECAL	1	\$3.40	
K20484	21.75" X 2.125" THIS VEHICLE STOPS DECAL	1	\$1.17	
K20485	22.75" X 2.125" ALL RAILROAD DECAL	1	\$1.17	
K20556	4.5" X 3.25"4 ANNUAL INSPECTION DECAL	1	\$1.18	
K1294	CARGO TANK TEST/INSPECTION DECAL	1	\$3.42	
K20821	3" X 2" ABS LIGHT DECAL	1	\$0.72	

****Decals can be ordered individually if needed.**

- MERCHANT GAS KITS

Merchant Gas

Oxygen Kit K50515 - \$24.42

PART #	DESCRIPTION	QTY	PRICE	IMAGE
K30212	8.26" X 2.07" BLACK REFLECTIVE	1	\$3.07	OXYGEN
K20961	15.92" X 4.2" BLACK REFLECTIVE	3	\$6.53	OXYGEN
K30221	20.76" X 2.07" BLACK REFLECTIVE	1	\$1.76	VENTING IS NORMAL

Merchant Gas

Nitrogen Kit K50522 - \$24.03

PART #	DESCRIPTION	QTY	PRICE	IMAGE
K30209	10.22" X 2.07" BLACK REFLECTIVE	1	\$2.68	NITROGEN
K20958	20.4" X 4.2" BLACK REFLECTIVE	3	\$6.53	NITROGEN
K30221	20.76" X 2.07" BLACK REFLECTIVE	1	\$1.76	VENTING IS NORMAL

Merchant Gas

Argon Kit K50518 - \$24.42

PART #	DESCRIPTION	QTY	PRICE	IMAGE
K30211	7.3" X 2.07" BLACK REFLECTIVE	1	\$3.07	ARGON
K20962	14.09" X 4.2" BLACK REFLECTIVE	3	\$6.53	ARGON
K30221	20.76" X 2.07" BLACK REFLECTIVE	1	\$1.76	VENTING IS NORMAL

Merchant Gas

Liquid Ethylene Kit K50516 - \$16.88

PART #	DESCRIPTION	QTY	PRICE	IMAGE
K30474	2" X 10.19" BLACK REFLECTIVE	1	\$3.05	ETHYLENE
K30475	4" X 20.38" BLACK REFLECTIVE	3	\$4.61	ETHYLENE

**Decals can be ordered individually if needed.

- MERCHANT GAS KITS

Merchant Gas

Liquid Hydrogen Kit K50519 - \$16.88

PART #	DESCRIPTION	QTY	PRICE	IMAGE
K30476	2.07" X 11.04" BLACK REFLECTIVE	1	\$3.05	HYDROGEN
K30477	4.2" X 22.43" BLACK REFLECTIVE	3	\$4.61	HYDROGEN

Merchant Gas

Lng Kit K50520 - \$15.44

PART #	DESCRIPTION	QTY	PRICE	IMAGE
K30478	2.07" X 14.04" BLACK REFLECTIVE	1	\$3.17	NATURAL GAS
K30479	4.2" X 28.34" BLACK REFLECTIVE	3	\$4.09	NATURAL GAS

Merchant Gas

Liquid Carbon Dioxide Kit K50517- \$15.44

PART #	DESCRIPTION	QTY	PRICE	IMAGE
K20956	4.2" X 33.38" BLACK REFLECTIVE	3	\$6.53	CARBON DIOXIDE
K30480	2.06" X 16.44" BLACK REFLECTIVE	1	\$4.09	CARBON DIOXIDE

**Decals can be ordered individually if needed.

- SPECIALTY PRODUCTS GROUP TANKER APPLICATION DIAGRAM

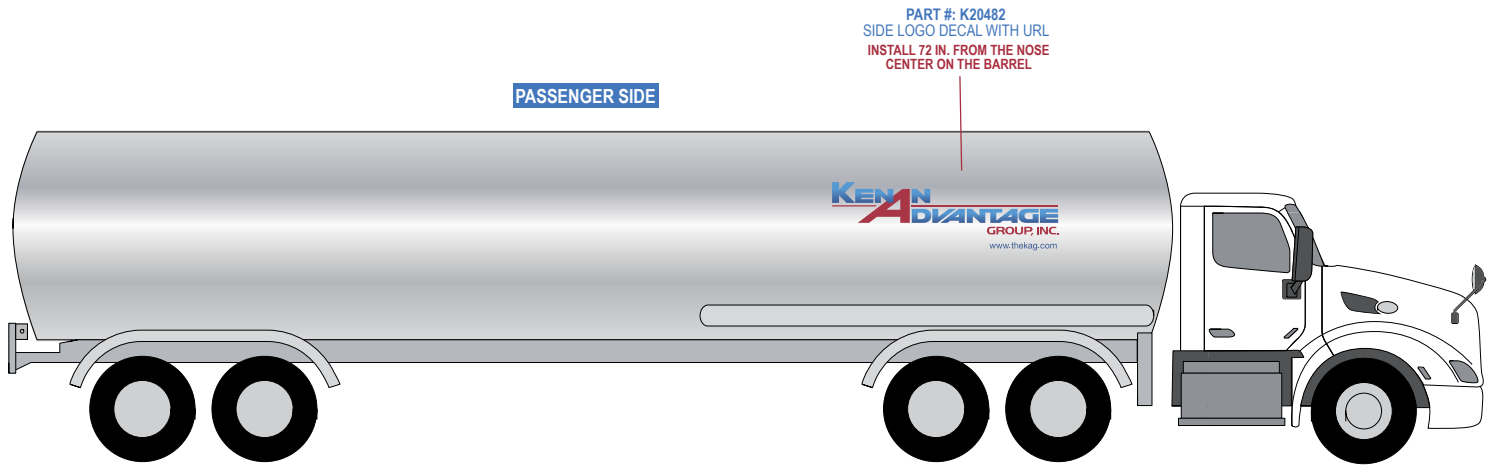

PART #: K20483
FRONT/REAR LOGO DECAL WITH URL
INSTALL 18 IN. FROM THE TOP
CENTER ON THE BARREL

FRONT

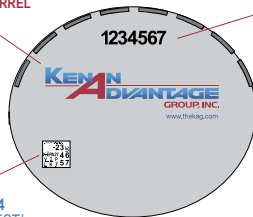

PART #: K20488R
4 IN. TALL BLACK REFLECTIVE UNIT NUMBERS
INSTALL 6" FROM THE TOP AND
CENTERED ON THE BARREL

REAR/BACK

PART #: K20483
FRONT/REAR LOGO DECAL WITH URL
INSTALL 18 IN. FROM THE TOP
CENTER ON THE BARREL

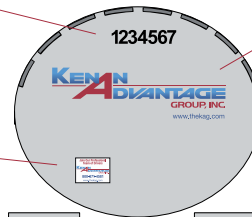

PART #: K20715
REAR HIRING DECAL
INSTALL 6" IN FROM LEFT SIDE
OF TANK AND 6" FROM BOTTOM
OF TANK SEAM



PART #: K1294
CARGO TANK TEST/
INSPECTION DECAL



INSTALL ON PASSENGER SIDE
6" FROM THE BOTTOM AND
6" IN FRONT LEFT SIDE



PART #: K20484
VEHICLE STOP DECAL
INSTALL IN THE CENTER OF THE REAR

PART #: K20485
RAILROAD CROSSING DECAL
INSTALL IN THE CENTER OF THE REAR

PART #: K20482
SIDE LOGO DECAL WITH URL
INSTALL 72 IN. FROM THE NOSE
CENTER ON THE BARREL

DRIVER SIDE

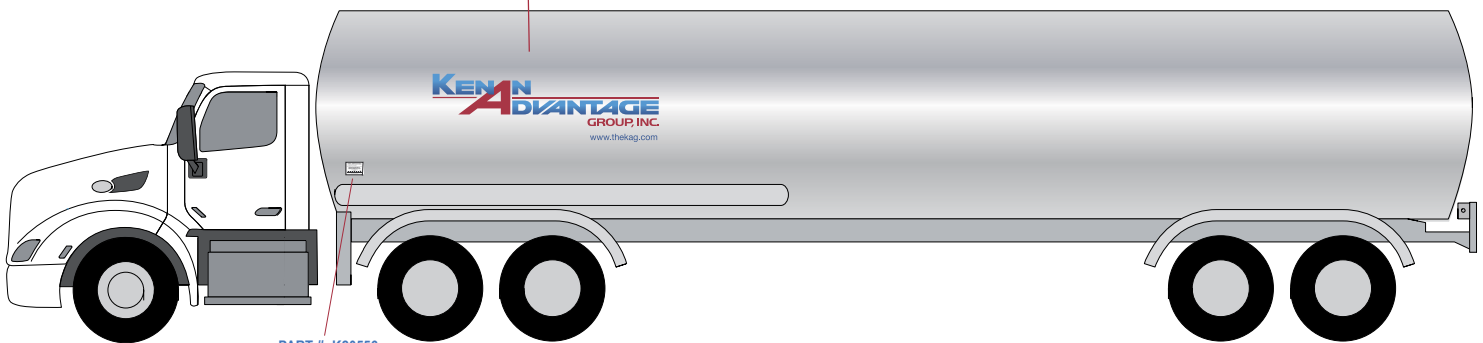







PART #: K20556
ANNUAL INSPECTION DECAL



INSTALL 2 IN. BACK FROM SEAM.
RIGHT ABOVE THE BRACKET

- SPECIALTY PRODUCTS GROUP TANKER - KIT K50506 - \$95.62

PART #	DESCRIPTION	QTY	PRICE	IMAGE
K20488R	4" TALL UNIT NUMBERS HORIZONTAL / BLACK REFLECTIVE	2	\$6.25	1234567
K20482	85.9" X 25.9" SIDE DECAL WITH URL	2	\$22.68	
K20715	16" X 12" REAR HIRING DECAL	1	\$3.40	
K20484	21.75" X 2.125" THIS VEHICLE STOPS DECAL	1	\$1.17	
K20485	22.75" X 2.125" ALL RAILROAD DECAL	1	\$1.17	
K20483	57.2" X 17.2" FRONT DECAL WITH URL	2	\$14.21	
K20556	4.5" X 3.25" ANNUAL INSPECTION DECAL	1	\$.18	
K1294	CARGO TANK TEST/INSPECTION DECAL	1	\$3.42	

**Decals can be ordered individually if needed.

- TANKER - SULFUR APPLICATION DIAGRAM

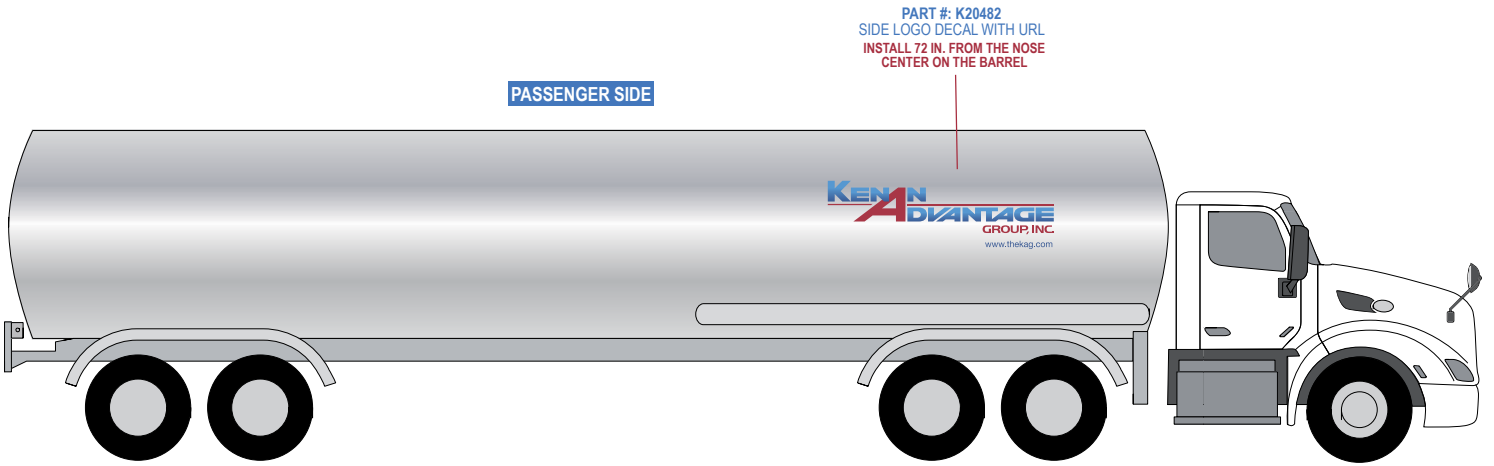

PART #: K20489
FRONT/REAR LOGO DECAL WITH URL
INSTALL 18 IN. FROM THE TOP
CENTER ON THE BARREL

FRONT

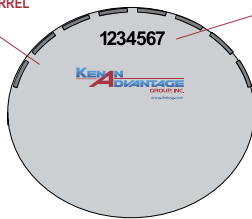

PART #: K20488R
4 IN. TALL BLACK REFLECTIVE UNIT NUMBERS
INSTALL 6" FROM THE TOP AND
CENTERED ON THE BARREL

REAR/BACK

PART #: K20489
FRONT/REAR LOGO DECAL WITH URL
INSTALL 18 IN. FROM THE TOP
CENTER ON THE BARREL

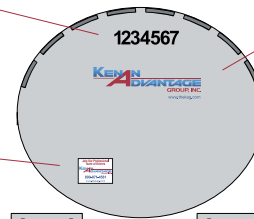

PART #: K20715
REAR HIRING DECAL
INSTALL 6" IN FROM LEFT SIDE
OF TANK AND 6" FROM BOTTOM
OF TANK SEAM



PART #: K20484
VEHICLE STOP DECAL
INSTALL IN THE CENTER OF THE REAR

PART #: K20485
RAILROAD CROSSING DECAL
INSTALL IN THE CENTER OF THE REAR

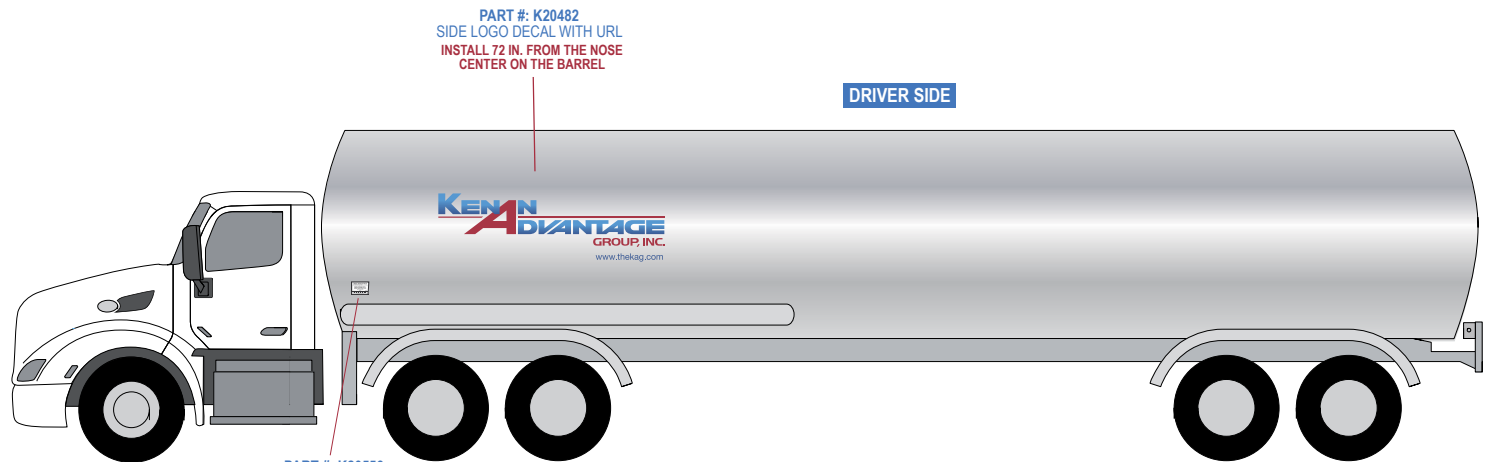

PART #: K20482
SIDE LOGO DECAL WITH URL
INSTALL 72 IN. FROM THE NOSE
CENTER ON THE BARREL







DRIVER SIDE

PART #: K20556
ANNUAL INSPECTION DECAL



INSTALL 2 IN. BACK FROM SEAM.
RIGHT ABOVE THE BRACKET

- TANKER - SULFUR KIT K50513 - \$75.81

PART #	DESCRIPTION	QTY	PRICE	IMAGE
K20488R	4" TALL UNIT NUMBERS HORIZONTAL / BLACK REFLECTIVE	2	\$6.25	1234567
K20482	85.9" X 25.9" SIDE DECAL WITH URL	2	\$22.68	
K20715	16" X 12" REAR HIRING DECAL	1	\$3.40	
K20484	21.75" X 2.125" THIS VEHICLE STOPS DECAL	1	\$1.17	
K20485	22.75" X 2.125" ALL RAILROAD DECAL	1	\$1.17	
K20489	32" X 9.65" REAR DECAL WITH URL	1	\$12.03	
K20556	4.5" X 3.25" ANNUAL INSPECTION DECAL	1	\$.18	

****Decals can be ordered individually if needed.**

- BURNER TANK WITH SMOKE STACK/CHIMNEY APPLICATION DIAGRAM

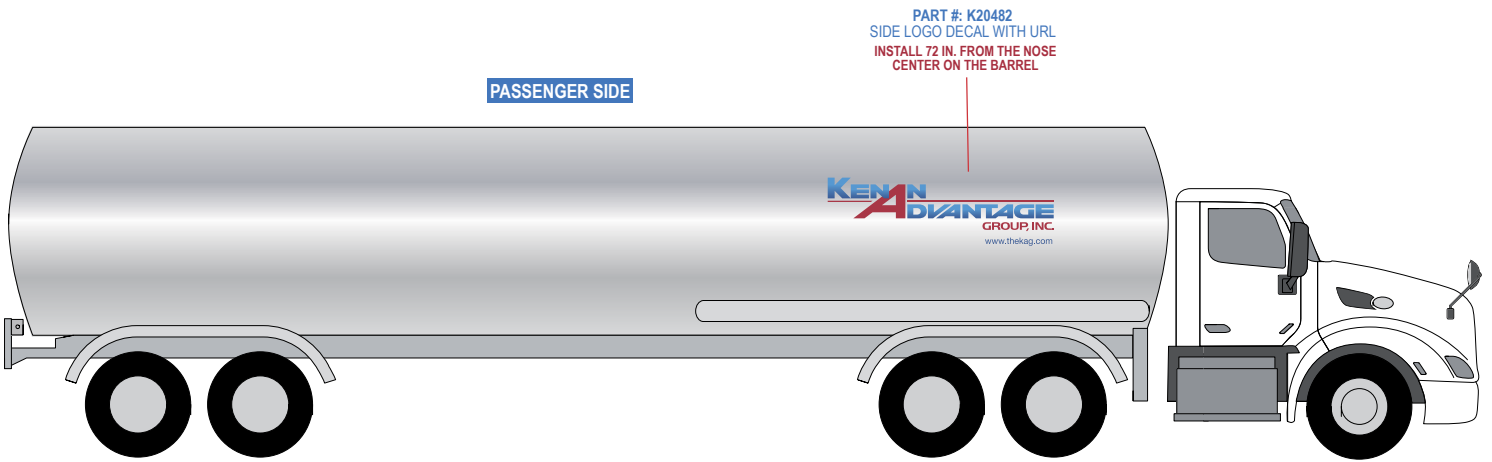

PART #: K20483
FRONT/REAR LOGO DECAL WITH URL
INSTALL 18 IN. FROM THE TOP
CENTER ON THE BARREL

FRONT

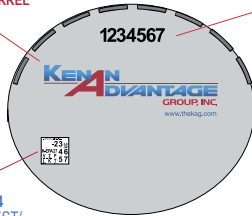

PART #: K20488R
4 IN. TALL BLACK REFLECTIVE UNIT NUMBERS
INSTALL 6" FROM THE TOP AND
CENTERED ON THE BARREL

REAR/BACK

PART #: K20489
REAR LOGO DECAL WITH URL
INSTALL 18 IN. FROM THE TOP
CENTER ON THE BARREL

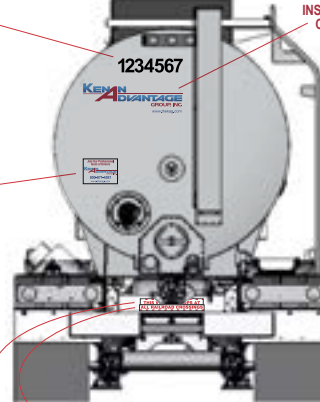

PART #: K20715
REAR HIRING DECAL
INSTALL 6" IN FROM LEFT SIDE
OF TANK AND 6" FROM BOTTOM
OF TANK SEAM



PART #: K1294
CARGO TANK TEST/
INSPECTION DECAL



INSTALL ON PASSENGER SIDE
6" FROM THE BOTTOM AND
6" IN FRONT LEFT SIDE



PART #: K20484
VEHICLE STOP DECAL
INSTALL IN THE CENTER OF THE REAR

PART #: K20485
RAILROAD CROSSING DECAL
INSTALL IN THE CENTER OF THE REAR

PART #: K20482
SIDE LOGO DECAL WITH URL
INSTALL 72 IN. FROM THE NOSE
CENTER ON THE BARREL

DRIVER SIDE

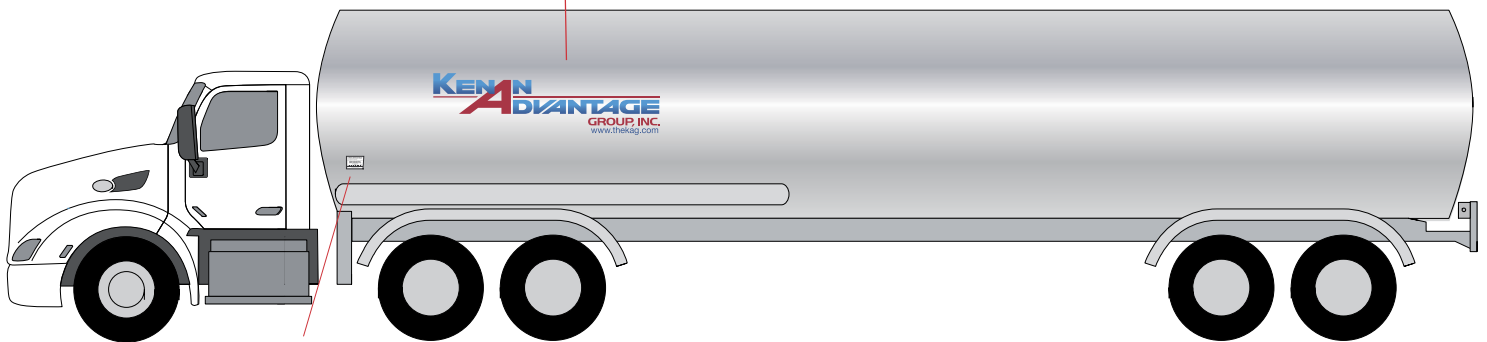







PART #: K20556
ANNUAL INSPECTION DECAL

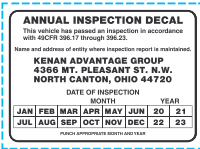

INSTALL 2 IN. BACK FROM SEAM.
RIGHT ABOVE THE BRACKET

- BURNER TANK WITH SMOKE STACK/CHIMNEY - KIT K50514 - \$50.26

PART #	DESCRIPTION	QTY	PRICE	IMAGE
K20488R	4" TALL UNIT NUMBERS HORIZONTAL / BLACK REFLECTIVE	2	\$6.25	1234567
K20483	57.2" X 17.2" FRONT DECAL WITH URL	2	\$14.21	
K20715	16" X 12" REAR HIRING DECAL	1	\$3.40	
K20484	21.75" X 2.125" THIS VEHICLE STOPS DECAL	1	\$1.17	
K20485	22.75" X 2.125" ALL RAILROAD DECAL	1	\$1.17	
K20556	4.5" X 3.25" ANNUAL INSPECTION DECAL	1	\$.18	
K1294	CARGO TANK TEST/INSPECTION DECAL	1	\$3.42	

****Decals can be ordered individually if needed.**

- PRODUCT IDENTIFICATION TANKER APPLICATION DIAGRAM

PASSENGER SIDE

PART #: K20482
SIDE LOGO DECAL WITH URL
INSTALL 72 IN. FROM THE NOSE
CENTER ON THE BARREL

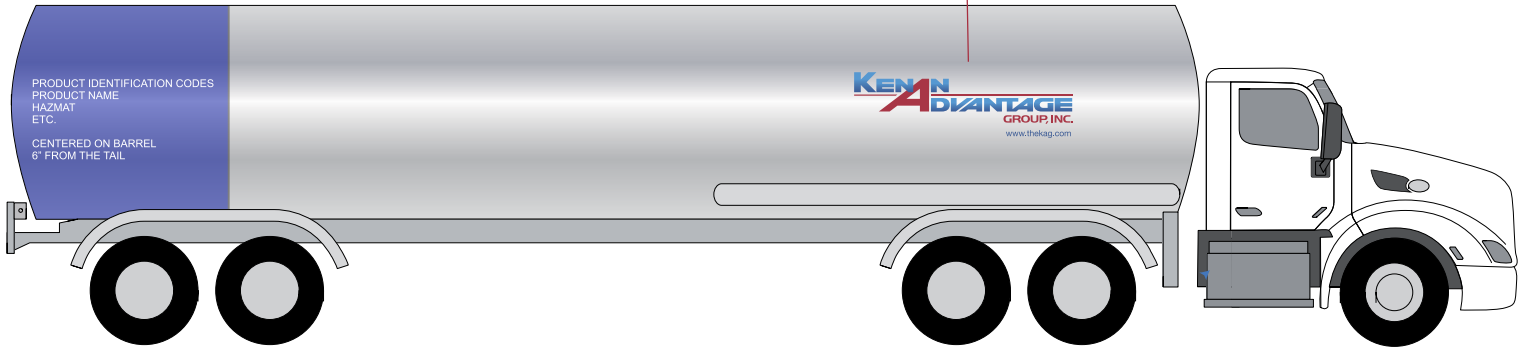

PART #: K20483
FRONT/REAR LOGO DECAL WITH URL
INSTALL 18 IN. FROM THE TOP
CENTER ON THE BARREL

FRONT

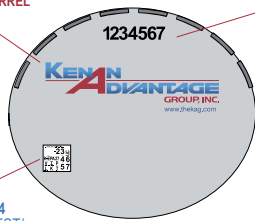

PART #: K20488R
4 IN. TALL BLACK REFLECTIVE UNIT NUMBERS
INSTALL 6" FROM THE TOP AND
CENTERED ON THE BARREL

REAR/BACK

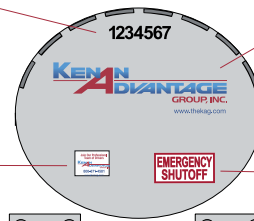

PART #: K20483
FRONT/REAR LOGO DECAL WITH URL
INSTALL 18 IN. FROM THE TOP
CENTER ON THE BARREL

PART #: K1294
CARGO TANK TEST/
INSPECTION DECAL



INSTALL ON PASSENGER SIDE
6" FROM THE BOTTOM AND
6" IN FRONT LEFT SIDE

PART #: K20715
REAR HIRING DECAL
INSTALL 6" IN FROM LEFT SIDE
OF TANK AND 6" FROM BOTTOM
OF TANK SEAM



PART #: K20965
EMERGENCY SHUTOFF
INSTALL ON THE RIGHT SIDE
OF THE SHUTOFF VALVE
AS CLOSE AS POSSIBLE



PART #: K20484
VEHICLE STOP DECAL
INSTALL IN THE CENTER OF THE REAR

PART #: K20485
RAILROAD CROSSING DECAL
INSTALL IN THE CENTER OF THE REAR

PART #: K20482
SIDE LOGO DECAL WITH URL
INSTALL 72 IN. FROM THE NOSE
CENTER ON THE BARREL

DRIVER SIDE

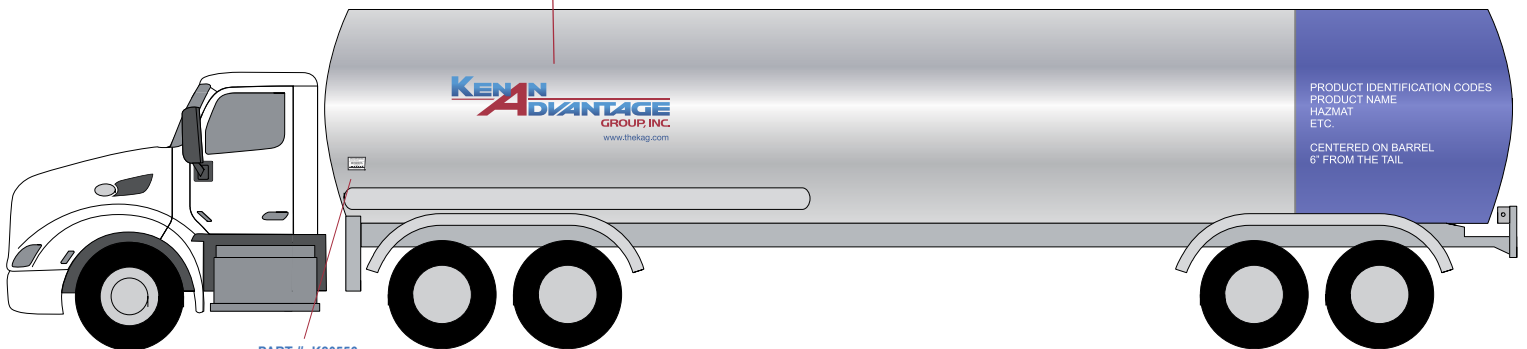









PART #: K20556
ANNUAL INSPECTION DECAL



INSTALL 2 IN. BACK FROM SEAM.
RIGHT ABOVE THE BRACKET

- PRODUCT IDENTIFICATION TANKER - K50510 - \$96.44

PART #	DESCRIPTION	QTY	PRICE	IMAGE
K20488R	4" TALL UNIT NUMBERS HORIZONTAL / BLACK REFLECTIVE	2	\$6.25	1234567
K20483	57.2" X 17.2" FRONT DECAL WITH URL	2	\$14.21	
K20482	85.9" X 25.9" SIDE DECAL WITH URL	2	\$22.68	
K20715	16" X 12" REAR HIRING DECAL	1	\$3.40	
K20484	21.75" X 2.125" THIS VEHICLE STOPS DECAL	1	\$1.17	
K20485	22.75" X 2.125" ALL RAILROAD DECAL	1	\$1.17	
K20965	6" X 3" EMERGENCY SHUT-OFF	1	\$.82	
K20556	4.5" X 3.25" ANNUAL INSPECTION DECAL	1	\$.18	
K1294	CARGO TANK TEST/INSPECTION DECAL	1	\$3.42	

**Decals can be ordered individually if needed.

- 39 FT. FRAMELESS DUMP TRUCK APPLICATION DIAGRAM

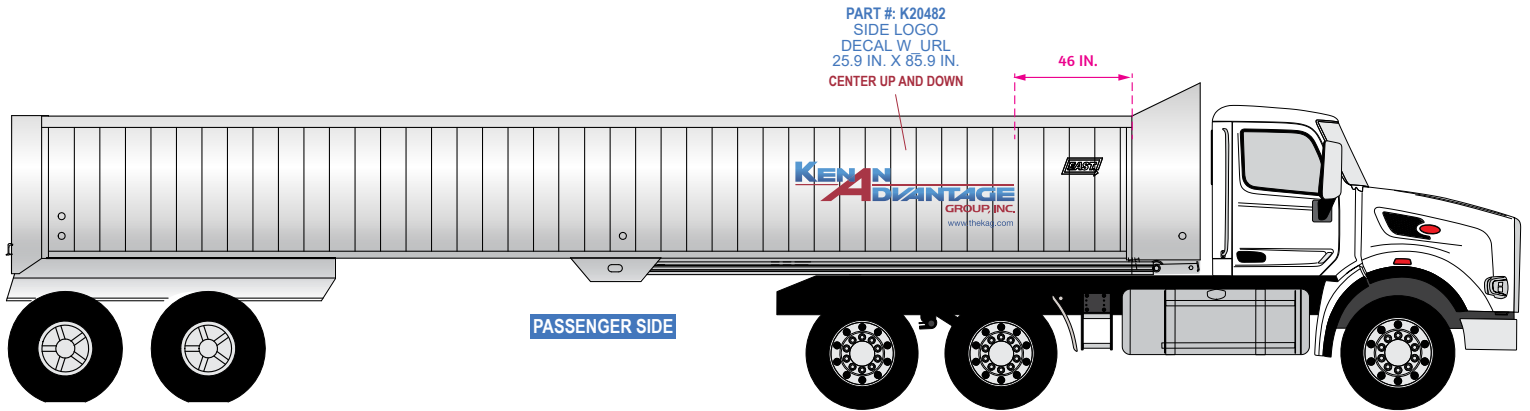

PART #: K20482
SIDE LOGO
DECAL W_URL
25.9 IN. X 85.9 IN.
CENTER UP AND DOWN

46 IN.

PASSENGER SIDE

PART #: K20489
FRONT/REAR LOGO
DECAL W_URL
9.65 IN. X 32 IN.
17.5 INCHES FROM TOP,
CENTER LEFT AND RIGHT.

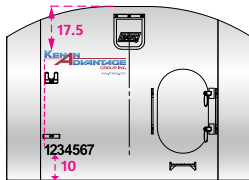

FRONT

PART #: K20488R
4 IN. TALL BLACK
REFLECTIVE
UNIT NUMBERS
ALIGN WITH LEFT
EDGE OF LOGO
10" FROM BOTTOM

PART #: K20488R
4 IN. TALL BLACK REFLECTIVE
UNIT NUMBERS
INSTALL 2" FROM
TOP AND EDGE.

PART #: K20489
FRONT/REAR LOGO
DECAL W_URL
9.65 IN. X 32 IN.
2 INCHES IN FROM
TOP AND EDGE.



REAR/BACK

PART #: K20715
REAR HIRING DECAL
INSTALL 2" IN FROM
BOTTOM AND EDGE.



PART #: K20482
SIDE LOGO
DECAL W_URL
25.9 IN. X 85.9 IN.
CENTER UP AND DOWN

46 IN.





DRIVER SIDE

PART #: K20556
INSPECTION DECAL
3.25 IN. X 4.5 IN.



1 INCH IN FROM
BOTTOM AND EDGE

- 39 FT. FRAMELESS DUMP TRUCK - KIT K50512 - \$85.50





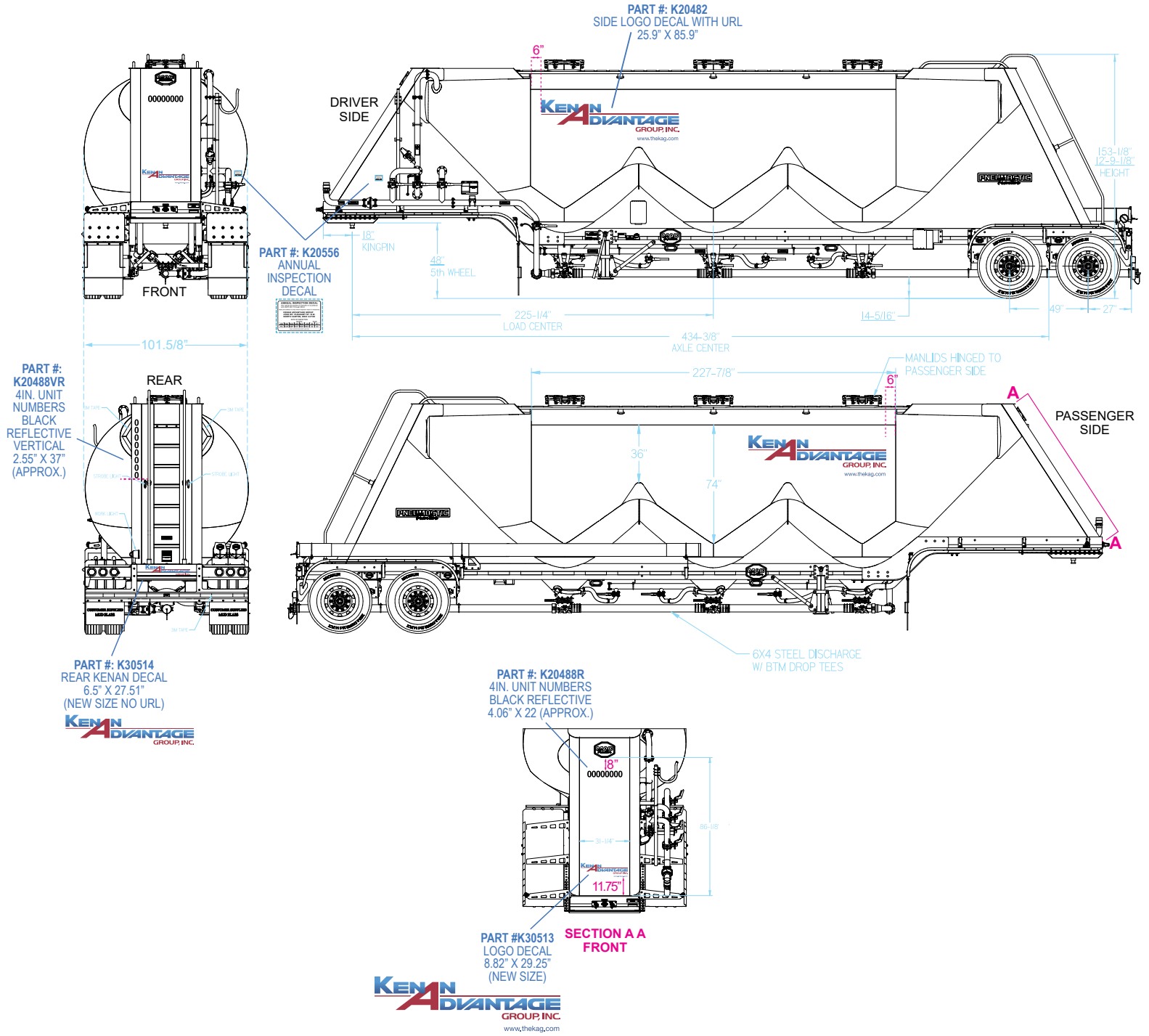

PART #	DESCRIPTION	QTY	PRICE	IMAGE
K20488R	4" TALL UNIT NUMBERS HORIZONTAL / BLACK REFLECTIVE	2	\$6.25	1234567
K20482	85.9" X 25.9" SIDE DECAL WITH URL	2	\$22.68	
K20715	16" X 12" REAR HIRING DECAL	1	\$3.40	
K20489	32" X 9.65" FRONT / REAR DECAL WITH URL	2	\$12.03	
K20556	4.5" X 3.25"4 ANNUAL INSPECTION DECAL	1	\$.18	

****Decals can be ordered individually if needed.**

- PNEUMATIC TANKER TRAILER APPLICATION DIAGRAM



- PNEUMATIC TANKER TRAILER - KIT K50523 - \$122.20

PART #	DESCRIPTION	QTY	PRICE	IMAGE
K20482	25.9" X 85.9" SIDE LOGO DECAL WITH URL	2	\$22.68	
K20556	4.5" X 3.25" ANNUAL INSPECTION DECAL	1	\$.18	
K30514	6.5" X 27.51" REAR KENAN DECAL (NEW SIZE NO URL)	1	\$32.08	
K20488VR	2.55" X 37" (APPROX) 4 IN UNIT NUMBER VERTICAL BLACK REFLECTIVE	1	\$6.25	
K20488R	4.06" X 22 (APPROX) 4 IN UNIT NUMBER BLACK REFLECTIVE	1	\$6.25	
K30513	8.82" X 29.25" (NEW SIZE) FRONT LOGO DECAL	1	\$32.08	

****Decals can be ordered individually if needed.**

- TANK CHASSIS APPLICATION DIAGRAM

MAGENTA SQUARES REPRESENT DECALS
NOT PRODUCED BY GRAPHIC IMPRESSIONS



MAGENTA OUTLINES REPRESENT CUT EDGE.

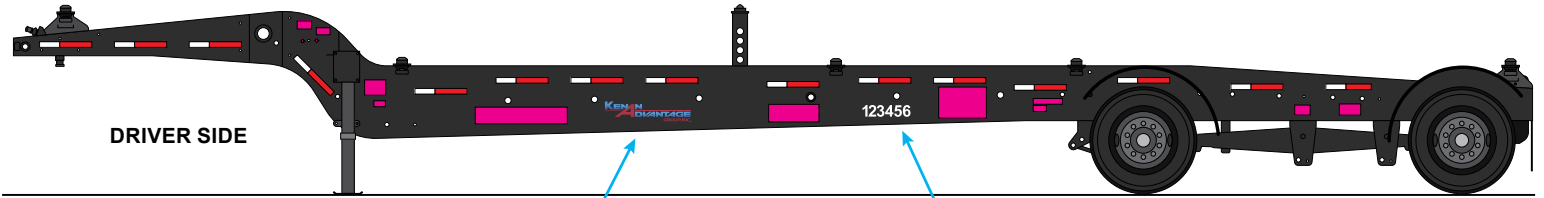

DRIVER SIDE



K30517
QTY: 2
CHASSIS SIDE LOGO
6.91" x 29.25"
(THIS IS ITEM K30513 MINUS THE URL)

123456
K20510 4" SEQUENCE UNIT NUMBER
QTY: 2

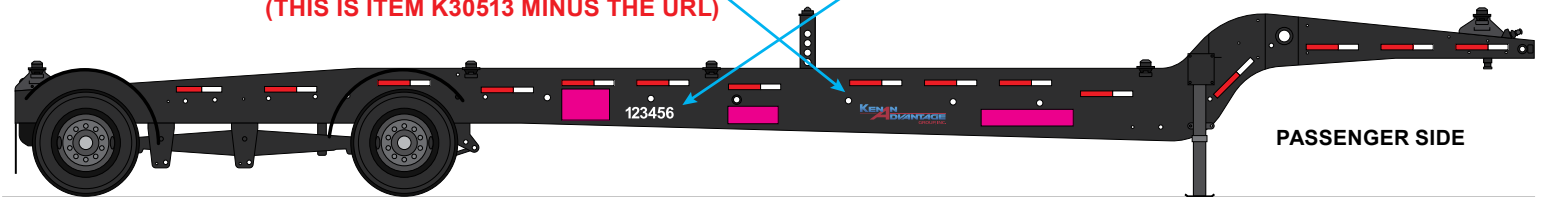

PASSENGER SIDE



K30516
QTY: 2
CHASSIS FRONT/REAR LOGO
2.56" x 10"
PRINTED ON TRANSPARENT MATERIAL WITH HALO CUT.

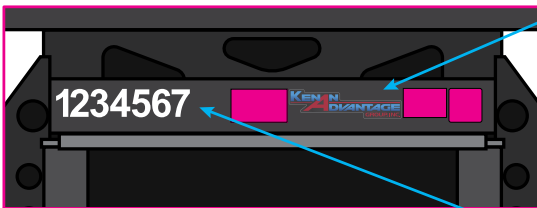

FRONT

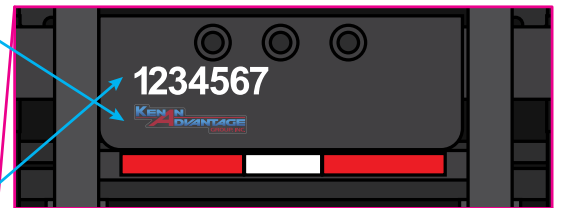



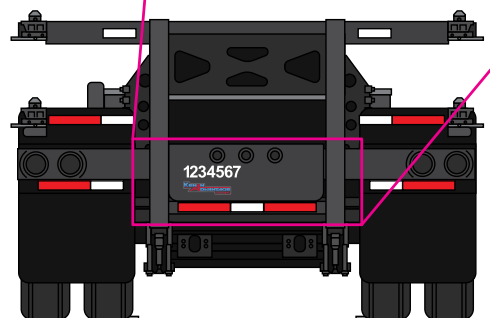
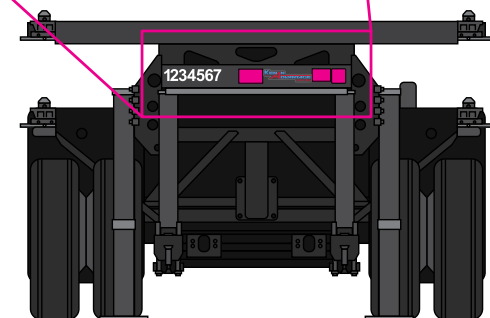

REAR

1234567
K20511 2.5" SEQUENCE UNIT NUMBER
QTY: 2



- TANK CHASSIS - KIT K50524 - \$62.54

PART #	DESCRIPTION	QTY	PRICE	IMAGE
K30517	6.91" x 29.25" CHASSIS SIDE LOGO	2	\$16.92	
K30516	2.56" X 10" CHASSIS FRONT/REAR LOGO	2	\$10.08	
K20511	2.5" TALL HORIZONTAL UNIT NUMBER SEQUENCE WHITE VINYL	2	\$1.95	
K20510	4" TALL HORIZONTAL UNIT NUMBER SEQUENCE WHITE VINYL	2	\$2.32	

****Decals can be ordered individually if needed.**

- MERCHANT GAS GROUP TANKER 4.2 IN. WORDS & 2 IN. WORDS

4.2 IN. WORD OPTIONS - FONT USED: ARIAL NARROW BOLD

PART #	DESCRIPTION	QUANTITY	IMAGE
K20956	33.38" X 4.2" BLACK REFLECTIVE	VARIES	CARBON DIOXIDE
K20957	43" X 4.2" BLACK REFLECTIVE	VARIES	REFRIGERATED LIQUID
K20958	20.4" X 4.2" BLACK REFLECTIVE	VARIES	NITROGEN
K20959	29.02" X 4.2" BLACK REFLECTIVE	VARIES	REFRIGERATED
K20960	12.2" X 4.2" BLACK REFLECTIVE	VARIES	LIQUID
K20961	15.92" X 4.2" BLACK REFLECTIVE	VARIES	OXYGEN
K20962	14.09" X 4.2" BLACK REFLECTIVE	VARIES	ARGON
K21013	40.8" X 4.2" BLACK REFLECTIVE	VARIES	CAUTION WIDE TURN
K21014	46.9" X 4.2" BLACK REFLECTIVE	VARIES	LIGHTS ON FOR SAFETY
K21012	19.76" X 4.2" BLACK REFLECTIVE	VARIES	METHANE
K20527	40" X 4.2 BLACK REFLECTIVE	VARIES	PROPYLENE GLYCOL
K20716	2" X 8.25 SQUARE CUT	VARIES	DEDICATED

2 IN. WORD OPTIONS - FONT USED: ARIAL NARROW BOLD

PART #	DESCRIPTION	QUANTITY	IMAGE
K30218	22.8" X 2.23" BLACK REFLECTIVE	VARIES	REFRIGERATED LIQUID
K30209	10.22" X 2.07" BLACK REFLECTIVE	VARIES	NITROGEN
K30212	8.26" X 2.07" BLACK REFLECTIVE	VARIES	OXYGEN
K30211	7.3" X 2.07" BLACK REFLECTIVE	VARIES	ARGON
K30214	11.28" X 2.03" BLACK REFLECTIVE	VARIES	WIDE TURN
K30213	9.7" X 2" BLACK REFLECTIVE	VARIES	METHANE
K30221	20.76" X 2.07" BLACK REFLECTIVE	VARIES	VENTING IS NORMAL
K30469	31.08" X 2.07" BLACK REFLECTIVE	VARIES	PUSH TO CLOSE PULL TO OPEN
K30470	18.81" X 2.07" BLACK REFLECTIVE	VARIES	DIESEL FUEL ONLY

- MERCHANT GAS GROUP 2" WORDS (CONT.) & FOOD GROUP TANKER WORD DECALS

2 IN. WORD OPTIONS - FONT USED: ARIAL NARROW BOLD

PART #	DESCRIPTION	QUANTITY	IMAGE
K30483	3.74" X 2.06" BLACK REFLECTIVE	VARIES	CO2
K30480	16.44"X 2.06" BLACK REFLECTIVE	VARIES	CARBON DIOXIDE
K20963	19.93" X 2.58" BLACK REFLECTIVE	VARIES	MOLTEN SULFUR



RAW MATERIALS -3M 680-85 (BLACK REFLECTIVE)

FOOD GROUP TANKER WORDS / FONT USED: ARIAL

PART #	DESCRIPTION	QUANTITY	IMAGE
K30451	25" X 4.13" VINEGAR	VARIES	VINEGAR
K30452	17" X 4.13" CIDER	VARIES	CIDER
K30453	25.67" X 4.13" PEPPERS	VARIES	PEPPERS
K30454	25" X 6.2" NGMO	VARIES	NGMO
K30429	24" X 4.2" NGMO	VARIES	INEDIBLE

- SEQUENCE UNIT NUMBERS

FONT USED: ARIAL NARROW BOLD













PART #	DESCRIPTION	QUANTITY	IMAGE
K20486	6" TALL UNIT NUMBER SEQUENCE HORIZONTAL / BLACK VINYL	VARIES	1234567890
K20486R	6" TALL UNIT NUMBER SEQUENCE HORIZONTAL / REFLECTIVE BLACK VINYL	VARIES	1234567890
K20488	4" TALL UNIT NUMBER SEQUENCE HORIZONTAL / BLACK VINYL	VARIES	1234567890
K20488V	4" TALL UNIT NUMBER SEQUENCE VERTICAL / BLACK VINYL	VARIES	1 2 3 4 5 6 7 8 9 0
K20488R	4" TALL UNIT NUMBER SEQUENCE HORIZONTAL / REFLECTIVE BLACK VINYL	VARIES	1234567890
K20488VR	4" TALL UNIT NUMBER SEQUENCE VERTICAL / BLACK REFLECTIVE VINYL	VARIES	1 2 3 4 5 6 7 8 9 0
K20994	2.5" TALL UNIT NUMBER SEQUENCE HORIZONTAL / BLACK VINYL	VARIES	1234567890
K20994R	2.5" TALL UNIT NUMBER SEQUENCE HORIZONTAL / BLACK REFLECTIVE VINYL	VARIES	1234567890
K20510	4" TALL UNIT NUMBER SEQUENCE HORIZONTAL / WHITE VINYL	VARIES	1234567890
K20511	2.5" TALL UNIT NUMBER SEQUENCE HORIZONTAL / WHITE VINYL	VARIES	1234567890
K20600	2.5" TALL UNIT NUMBER SEQUENCE HORIZONTAL / SAPPHIRE BLUE VINYL	VARIES	1234567890
K20601	4" TALL UNIT NUMBER SEQUENCE HORIZONTAL / SAPPHIRE BLUE VINYL	VARIES	1234567890
K30331	32" X 1.5" HORIZONTAL 6" TALL UNIT NUMBER SEQUENCE INSTALL TEMPLATE	VARIES	
K30333	18.3" X 0.6" HORIZONTAL 2.5" TALL UNIT NUMBER SEQUENCE INSTALL TEMPLATE	VARIES	

- INDIVIDUAL UNIT NUMBERS

FONT USED: ARIAL NARROW BOLD

PART #	DESCRIPTION	QUANTITY	IMAGE
K20196	2.5" TALL INDIVIDUAL NUMBER SAPPHIRE BLUE VINYL	VARIES	1234567890
K20488Y	2" TALL INDIVIDUAL NUMBER YELLOW VINYL	VARIES	1234567890
K20488Z	2" TALL INDIVIDUAL NUMBER BLACK VINYL	VARIES	1234567890
K20512	2.5" TALL INDIVIDUAL NUMBER WHITE VINYL	VARIES	1234567890
K20513	4" TALL INDIVIDUAL NUMBER WHITE VINYL	VARIES	1234567890
K20763	2" TALL INDIVIDUAL NUMBER BLACK VINYL (USED FOR PVIK NUMBERS)	VARIES	1234567890
K20816	2.5" TALL INDIVIDUAL NUMBER BLACK VINYL	VARIES	1234567890
K20816R	2.5" TALL INDIVIDUAL NUMBER BLACK VINYL REFLECTIVE	VARIES	1234567890
K20818	4" TALL INDIVIDUAL NUMBER BLACK VINYL	VARIES	1234567890
K20818R	4" TALL INDIVIDUAL NUMBER BLACK VINYL REFLECTIVE	VARIES	1234567890
K20819	4" TALL INDIVIDUAL NUMBER SAPPHIRE BLUE VINYL	VARIES	1234567890
K20952	6" TALL INDIVIDUAL NUMBER WHITE VINYL	VARIES	1234567890
K20954	6" X 7" 6" TALL WHITE LETTER/NUMBER WITH BLUE BACKGROUND VARIABLE DATA - ANY LETTER OR NUMBER CAN BE ORDERED	VARIES	C 8
K30468	4" TALL WHITE LETTER/NUMBER W/BUE BACKGROUND (FINISHED SIZE 4.5" X 3.75")	VARIES	1234567890 ABCDEFGHIJKLM NOPQRSTUVWXYZ

- TANK COLLARS DECALS

PART #	DESCRIPTION	QUANTITY	IMAGE
K30220	32" X 3.5" 87 OXY TANK COLLAR	1	
K30400	32" X 3.5" #2 BIO TANK COLLAR	1	
K30401	32" X 3.5" OXY PREMIUM TANK COLLAR	1	
K30402	32" X 3.5" MID GRADE TANK COLLAR	1	
K30403	32" X 3.5" #1 DIESEL TANK COLLAR	1	
K30404	32" X 3.5" DYED DIESEL TANK COLLAR	1	
K30405	32" X 3.5" DIESEL W/BIO TANK COLLAR	1	
K30406	32" X 3.5" B-5 CLEAR TANK COLLAR	1	
K30407	32" X 3.5" E-85 TANK COLLAR	1	
K30408	32" X 3.5" DEF TANK COLLAR	1	
K30409	32" X 3.5" NO LEAD TANK COLLAR	1	
K30410	32" X 3.5" UNLEADED CONVENTIONAL TANK COLLAR	1	

RAW MATERIALS
-3ML STYRENE

- TANK COLLARS DECALS



PART #	DESCRIPTION	QUANTITY	IMAGE
K30411	32" X 3.5" PREMIUM TANK COLLAR	1	
K30412	32" X 3.5" PREMIUM CONVENTIONAL TANK COLLAR	1	
K30413	32" X 3.5" PREMIUM W/ETHANOL TANK COLLAR	1	
K30414	32" X 3.5" KEROSENE TANK COLLAR	1	
K30415	32" X 3.5" REC NON-ETHANOL TANK COLLAR	1	
K30416	32" X 3.5" DYED KROSENE TANK COLLAR	1	
K30417	32" X 3.5" CONVENTIONAL MIDGRADE TANK COLLAR	1	
K30418	32" X 3.5" #2 DIESEL TANK COLLAR	1	
K30419	32" X 3.5" RACING FUEL TANK COLLAR	1	
K30420	32" X 3.5" UNLEADED W/ETHANOL TANK COLLAR	1	
K30423	32" X 3.5" 87 OXY TANK COLLAR	1	

RAW MATERIALS
-3ML STYRENE



- KAG TANKER DECAL REPLACEMENT DETAIL

PART #	DESCRIPTION	QUANTITY	IMAGE
K20715	12" X 16" REAR HIRING DECAL	1	
K20965	3" X 6" EMERGENCY SHUT-OFF DECAL	1	
K21113	6" X 6" 72 HOUR DECAL	1	
K20953	2.75" X 1.75" CALIBRATION DECAL GOES ON METER IN BOX	1	
K21114	7" X 12" KAG LEASING DECAL	1	
K1294	CARGO TANK TEST/INSPECTION DECAL	1	
MAGNOLIA USE ONLY	16" X 8" MAGNOLIA USE ONLY	1	
CHARLOTTE USE ONLY	16" X 8" CHARLOTTE USE ONLY	1	





- KAG TANKER DECAL REPLACEMENT DETAIL

PART #	DESCRIPTION	QUANTITY	IMAGE
K20826	8" X 6" INTRANSIT HEAR PROPYLENE GLYCOL ANTI-FREEZE ONLY	1	
K20827	4.5" X 3.5" INTRANSIT HEAT PROPYLENE GLYCOL ANTI-FREEZE ONLY	1	
K21074	16" X 2" FIRE EXTINGUISHER INSIDE	1	
K20556	4.5" X 3.25" ANNUAL INSPECTION DECAL	1	
K20821	3" X 2" ABS LIGHT DECAL	1	
K30206	25.5" X 3.1" WEBSITE ONLY	1	
K30456	4" X 3" 90 DAY SULFUR DECAL	1	









- KAG TANKER DECAL REPLACEMENT DETAIL

PART #	DESCRIPTION	QUANTITY	IMAGE
K20481	65.5" X 24.5" FRONT AND REAR TANKER COVER UP	1	
K20480R	128" X 36" RIGHT SIDE TANKER COVER UP	1	
K20480L	128" X 36" LEFT SIDE TANKER COVER UP	1	
K20517	31.5" X 6" FLAMMABLE	1	FLAMMABLE









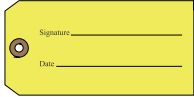

- KAG WALL DECALS

PART #	DESCRIPTION	QUANTITY	IMAGE
K30458	44.9" X 17.38" KAG SPECIALTY PRODUCTS SIGN		
K30459	44.9" X 10.48" KAG SIGN		
K30481	72" X 30.93" KAG ENERGY		
K30494	13.89" X 44.9" KAG KENAN ADVANTAGE GROUP WALL DECAL		
K30498	27.04" X 85.9" KAG KENAN ADVANTAGE GROUP WALL DECAL		





- CUSTOMER SPECIFIC DECALS

PART #	DESCRIPTION	QUANTITY	IMAGE
AIM SPG LOGO	22.2" X 7.5" AIM SPG LOGO	1	
BCI LOGO	29" X 11.5" BCI LOGO	1	
K30330	7.5" X 8.5" WHITE AIM	2	
K30225	7.5" X 8.5" RED AIM	2	
K30224	15.3" X 2.1" OPERATED BY - BLUE	2	
K30231	15.3" X 2.1" OPERATED BY - BLACK	2	
K30460	4.5" X 14.5" PULL TO UNLOAD DECAL	1	
K30461	4.5" X 14.5" DOWN TO UNLOAD DECAL	1	

- MISCELLANEOUS

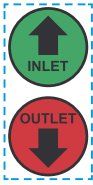
PART #	DESCRIPTION	QTY	PRICE	IMAGE
K20873	5.75" X 2.875" INSPECTED YELLOW TAG	VARIABLES	---	  <p>FRONT BACK</p>
K20874	6.25" X 3.125" OUT OF SERVICE TAG	VARIABLES	---	  <p>FRONT BACK</p>
K20875	5.75" X 2.875" CLEAN TAG	VARIABLES	---	  <p>FRONT BACK</p>
K20876	6.25" X 3.125" LOADED TAG	VARIABLES	---	  <p>FRONT BACK</p>
K30230	3" X 2" KAG MERCHANT GAS HARD HAT STICKER	1	---	
K30338	23.9" X 4.2" BLACK REFLECTIVE VINYL NON-CODE	1	---	NON-CODE
K30339	23.9" X 4.2" BLACK REFLECTIVE VINYL STORAGE ONLY	1	---	STORAGE ONLY
K20877	23" X 3.4" WARNING - LIQUID NITROGEN	1	---	
K20878	26.9" X 13.4" WARNING - LIQUID CARBON DIOXIDE	1	---	
K30428	5.08" X 33.62" WISCONSIN DOR REGISTRATION NUMBER	1	\$5.95	WDR-T5477

- MISCELLANEOUS

PART #	DESCRIPTION	QTY	PRICE	IMAGE
K20518	4" X 8" INLET OUTLET STICKER	1	---	
K30236	24" X 8" JET FUEL	1	---	
K30341	29.2" X 9.4" HYDROGEN PEROXIDE REFLECTIVE BLACK VINYL	1	---	HYDROGEN PEROXIDE
K30228	14.7" X 2.1" ODORIZED	1	---	ODORIZED
K30229	8" X 3" NON- (MAGNET)	1	---	NON-
K30337	30.3" X 4.2" NON-KOSHER	1	---	NON-KOSHER
K30335	18" X 12" JACK B. KELLEY MEXICO	1	---	
K30440	13.5" X 6" LIQUID ETHYLENE VALVE IDENTIFICATION	1	---	
K30442	64" X 4.5" DEDICATED ST. ELMO	1	---	DEDICATED ST. ELMO
K30464	4.31" x 59.28" LIQUEFIED PETROLEUM GAS	1	---	LIQUEFIED PETROLEUM GAS

- MISCELLANEOUS

PART #	DESCRIPTION	QUANTITY	IMAGE
K30449	6" X 2' ITH GOOD	1	
K30448	6" X 2" STM ONLY	1	
K30450	12" X 8" DEDICATED MDI	1	
BULKHEAD02	32.5" X 9" BULKHEAD DECAL	1	
BULKHEAD ORIGINAL	32.5" X 9" BULKHEAD DECAL	1	
K30466	2.15" X 3.77" 2 INCH TALL QT DECAL	1	
K30467	2.15" X 5.74" 2 INCH TALL NQT DECAL	1	
K30489	6" x 7" EMERGENCY SPILL RESPONSE EQUIPMENT DECAL	1	
K30515	6" x 6" UNIVERSAL WASTE DECAL	1	
K30521	3" x 3" SLI DECAL	1	
K30427	CARBON EXPRESS REGISTRATION NUMBER TNH-0517	1	

For Reorders Contact:

GRAPHICIMPRESSIONS

620-663-5939

<https://kenan.graphicimpressions1.com/>

Thank you in advance for the order.